

SEVENTH EDITION

# Fundamentals of Thermodynamics

BORGNAKKE | SONNTAG

## SOLUTION MANUAL CHAPTER 3

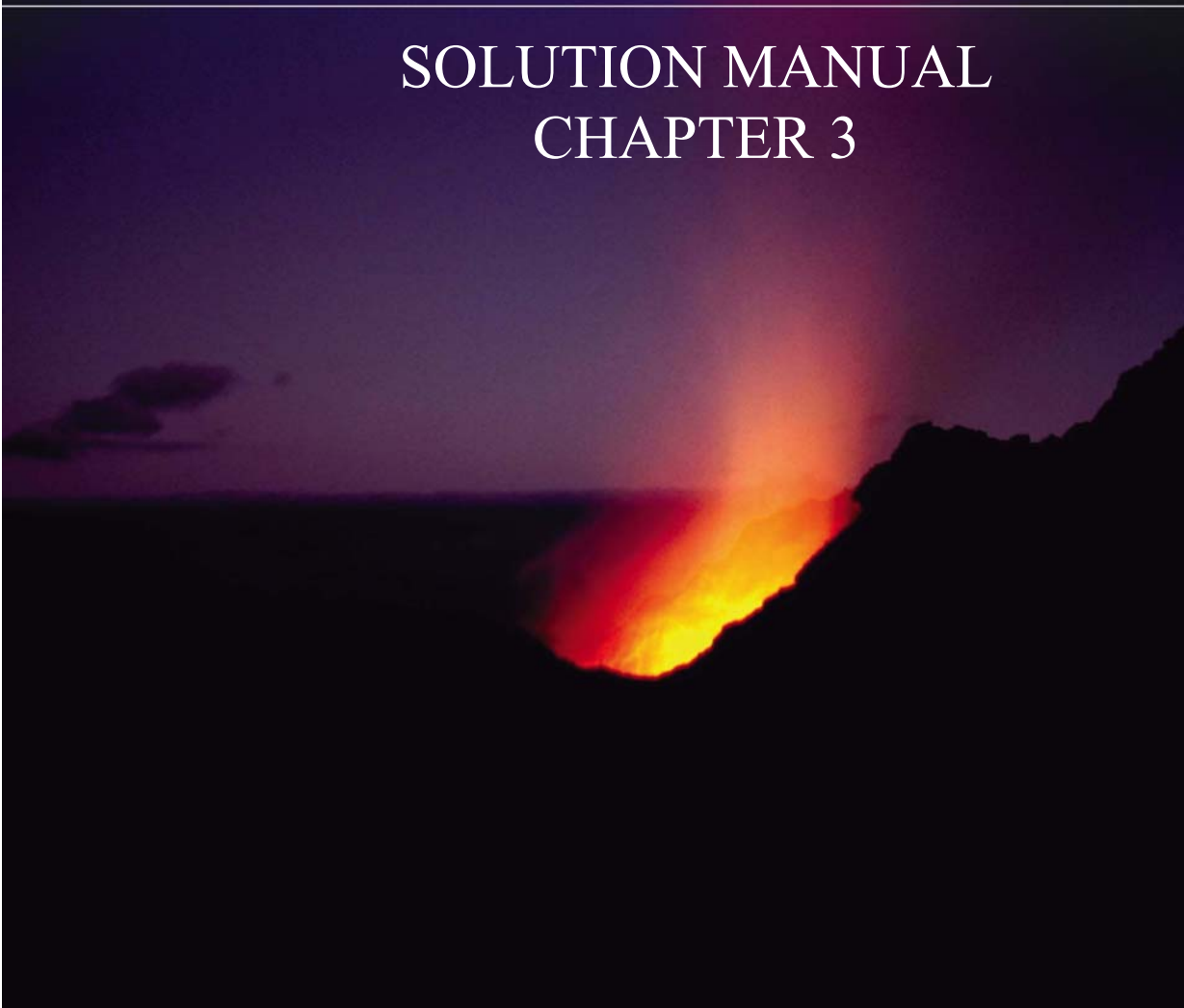

**CONTENT CHAPTER 3**

<b>SUBSECTION</b>	<b>PROB NO.</b>
Concept problems	1-15
Phase diagrams, triple and critical points	16-24
General tables	25-64
Ideal gas	65-84
Compressibility factor	85-97
Equations of state	98-106
Review problems	107-125
Linear interpolation	126-130
Computer tables	131-135

Excerpts from this work may be reproduced by instructors for distribution on a not-for-profit basis for testing or instructional purposes only to students enrolled in courses for which this textbook has been adopted. *Any other reproduction or translation of this work beyond that permitted by Sections 107 or 108 of the 1976 United States Copyright Act without the permission of the copyright owner is unlawful.*

## In-Text Concept Questions

Excerpts from this work may be reproduced by instructors for distribution on a not-for-profit basis for testing or instructional purposes only to students enrolled in courses for which this textbook has been adopted. *Any other reproduction or translation of this work beyond that permitted by Sections 107 or 108 of the 1976 United States Copyright Act without the permission of the copyright owner is unlawful.*

**3.a**

If the pressure is smaller than  $P_{\text{sat}}$  at a given  $T$ , what is the phase?

Refer to the phase diagrams in Figures 3.6 and 3.7. For a lower  $P$  you are below the vaporization curve and that is the superheated vapor region. You have the gas phase.

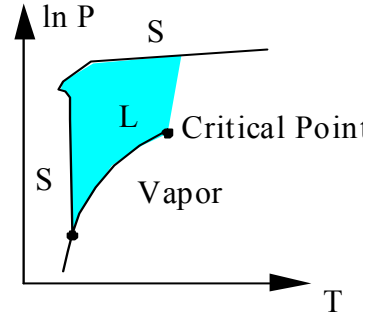
**3.b**

An external water tap has the valve activated by a long spindle so the closing mechanism is located well inside the wall. Why is that?

Solution:

By having the spindle inside the wall the coldest location with water when the valve is closed is kept at a temperature above the freezing point. If the valve spindle was outside there would be some amount of water that could freeze while it is trapped inside the pipe section potentially rupturing the pipe.

## 3.c

What is the lowest temperature (approximately) at which water can be liquid?

Look at the phase diagram in Fig. 3.7. At the border between ice I, ice III and the liquid region is a triple point which is the lowest T where you can have liquid. From the figure it is estimated to be about 255 K i.e. at  $-18^{\circ}\text{C}$ .

$$T \approx 255 \text{ K} \approx -18^{\circ}\text{C}$$

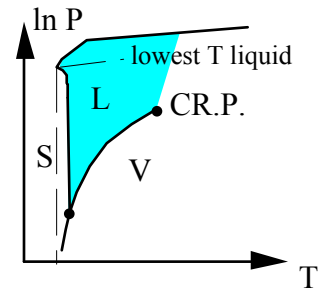

**3.d**

Some tools should be cleaned in water at a least 150°C. How high a P is needed?

Solution:

If I need liquid water at 150°C I must have a pressure that is at least the saturation pressure for this temperature.

Table B.1.1: 150°C,  $P_{\text{sat}} = 475.9 \text{ kPa}$ .

**3.e**

Water at 200 kPa has a quality of 50%. Is the volume fraction  $V_g/V_{\text{tot}} < 50\%$  or  $> 50\%$ ?

This is a two-phase state at a given pressure without looking in the table we know that  $v_f$  is much smaller than  $v_g$ .

From the definition of quality we get the masses from total mass,  $m$ , as

$$m_f = (1 - x) m, \quad m_g = x m$$

The volumes are

$$V_f = m_f v_f = (1 - x) m v_f, \quad V_g = m_g v_g = x m v_g$$

So when half the mass is liquid and the other half is vapor the liquid volume is much smaller than the vapor volume.

**3.f**

Why are most of the compressed liquid or solid regions not included in the printed tables?

For the compressed liquid and the solid phases the specific volume and thus density is nearly constant. These surfaces are very steep nearly constant  $v$  and there is then no reason to fill up a table with the same value of  $v$  for different  $P$  and  $T$ .

**3.g**

Why is it not typical to find tables for Ar, He, Ne or air like an Appendix B table?

The temperature at which these substances are close to the two-phase region is very low. For technical applications with temperatures around atmospheric or higher they are ideal gases. Look in Table A.2 and we can see the critical temperatures as

Ar : 150.8 K            He: 5.19 K            Ne: 44.4 K

It requires a special refrigerator in a laboratory to bring a substance down to these cryogenic temperatures.



**3.h**

What is the percent change in volume as liquid water freezes? Mention some effects in nature and for our households the volume change can have.

The density of water in the different phases can be found in Tables A.3 and A.4 and in Table B.1.

$$\text{From Table B.1.1} \quad v_f = 0.00100 \text{ m}^3/\text{kg}$$

$$\text{From Table B.1.5} \quad v_i = 0.0010908 \text{ m}^3/\text{kg}$$

$$\text{Percent change:} \quad 100 \frac{v_i - v_f}{v_f} = 100 \times \frac{0.0010908 - 0.001}{0.001} = 9.1 \% \text{ increase}$$

Liquid water that seeps into cracks or other confined spaces and then freezes will expand and widen the cracks. This is what destroys any porous material exposed to the weather on buildings, roads and mountains. It can burst water pipes and crack engine blocks (that is why you put anti-freeze in it).

**3.i**

How accurate is it to assume that methane is an ideal gas at room conditions?

From Table A.2:  $T_c = 190.4 \text{ K}$ ,  $P_c = 4.60 \text{ MPa}$

So at room conditions we have much higher  $T > T_c$  and  $P \ll P_c$  so this is the ideal gas region. To confirm look in Table B.7.2

$$100 \text{ kPa}, 300 \text{ K}, \quad v = 1.55215 \text{ m}^3/\text{kg}$$

Find the compressibility factor (R from Table A.5) as

$$Z = Pv/RT = \frac{100 \text{ kPa} \times 1.55215 \text{ m}^3/\text{kg}}{0.5183 \text{ kJ/kg-K} \times 300 \text{ K}} = 0.99823$$

so  $Z$  is 1 with an accuracy of 0.2% better than most measurements can be done.

**3.j**

I want to determine a state of some substance, and I know that  $P = 200$  kPa; is it helpful to write  $PV = mRT$  to find the second property?

NO. You need a second property.

Notice that two properties are needed to determine a state. The EOS can give you a third property if you know two, like (P,T) gives  $v$  just as you would get by entering a table with a set (P,T). This EOS substitutes for a table when it is applicable.

**3.k**

A bottle at 298 K should have liquid propane; how high a pressure is needed? (use Fig. D.1)

To have a liquid the pressure must be higher than or equal to the saturation pressure. There is no printed propane table so we use the compressibility chart and Table A.2

Propane Table A.2:  $T_c = 369.8 \text{ K}$ ,  $P_c = 4.25 \text{ MPa}$

The reduced temperature is:

$$T_r = \frac{T}{T_c} = \frac{298}{369.8} = 0.806,$$

for which we find in Fig. D.1:  $P_{r \text{ sat}} = 0.25$

$$P = P_{r \text{ sat}} P_c = 0.25 \times 4.25 \text{ MPa} = \mathbf{1.06 \text{ MPa}}$$

## 3.1

A bottle at 298 K should have liquid propane; how high a pressure is needed? (use the software)

To have a liquid the pressure must be higher than or equal to the saturation pressure. There is no printed propane table but the software has propane included

Start CATT3, select cryogenic substances, propane

select calculator, select T, x = (25C, 0)  $\Rightarrow$  P = **0.9518 MPa**

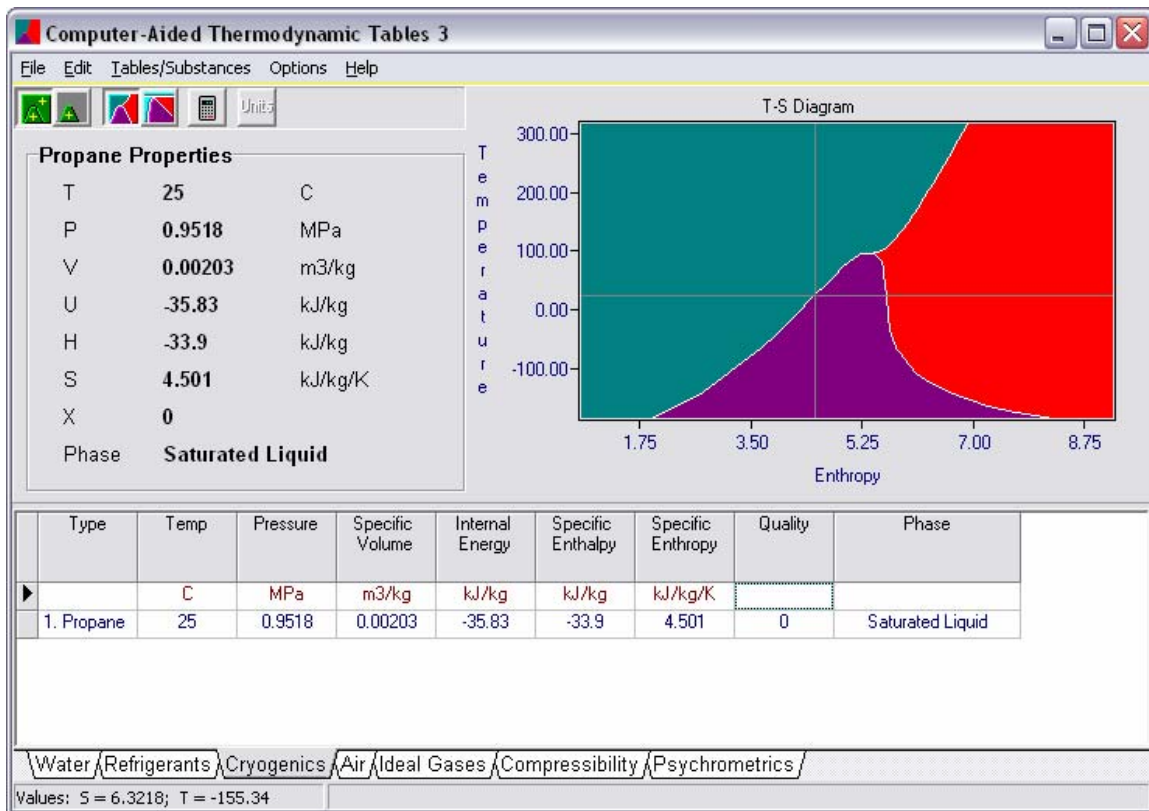

Excerpts from this work may be reproduced by instructors for distribution on a not-for-profit basis for testing or instructional purposes only to students enrolled in courses for which this textbook has been adopted. Any other reproduction or translation of this work beyond that permitted by Sections 107 or 108 of the 1976 United States Copyright Act without the permission of the copyright owner is unlawful.

## Concept Problems

Excerpts from this work may be reproduced by instructors for distribution on a not-for-profit basis for testing or instructional purposes only to students enrolled in courses for which this textbook has been adopted. *Any other reproduction or translation of this work beyond that permitted by Sections 107 or 108 of the 1976 United States Copyright Act without the permission of the copyright owner is unlawful.*

**3.1**

Are the pressures in the tables absolute or gauge pressures?

Solution:

The behavior of a pure substance depends on the absolute pressure, so  $P$  in the tables is absolute.

**3.2**

What is the minimum pressure for which I can have liquid carbon dioxide?

Look at the phase diagram in Fig. 3.6. The minimum  $P$  in the liquid phase is at the triple point. From Table 3.2 this is at **520 kPa** (a similar around 4-500 kPa is seen in Fig. 3.6).



### 3.3

When you skate on ice, a thin liquid film forms under the skate. How can that be?

The ice is at some temperature below the freezing temperature for the atmospheric pressure of  $100 \text{ kPa} = 0.1 \text{ MPa}$  and thus to the left of the fusion line in the solid ice I region of Fig. 3.7. As the skate comes over the ice the pressure is increased dramatically right under the blade so it brings the state straight up in the diagram crossing the fusion line and brings it into a liquid state at same temperature.

The very thin liquid film under the skate changes the friction to be viscous rather than a solid to solid contact friction. Friction is thus significantly reduced.

Comment: The latest research has shown that the pressure may not be enough to generate the liquid, but that such a liquid layer always exist on an ice surface, maybe only a few molecules thick (dependent upon temperature).

**3.4**

At a higher elevation like in mountains the pressure is lower, what effect does that have for cooking food?

A lower pressure means that water will boil at a lower temperature, see the vaporization line in Fig. 3.7, or in Table B.1.2 showing the saturated temperature as a function of the pressure. You therefore must increase the cooking time a little.

**3.5**

Water at room temperature and room pressure has  $v \approx 1 \times 10^n \text{ m}^3/\text{kg}$  what is  $n$ ?

See Table B.1.1 or B.1.2 to determine it is in the liquid phase (you should know this already).

Table A.4 or from B1.1 at 20°C:  $n = -3$  ( $v = 0.00100 \text{ m}^3/\text{kg}$ )

**3.6**

In Example 3.1 b is there any mass at the indicated specific volume? Explain.

This state is a two-phase mixture of liquid and vapor. There is no mass at the indicated state, the  $v$  value is an average for all the mass, so there is some mass at the saturated vapor state (fraction is the quality  $x$ ) and the remainder of the mass is saturated liquid (fraction  $1-x$ ).

## 3.7

Sketch two constant-pressure curves (500 kPa and 30 000 kPa) in a T-v diagram and indicate on the curves where in the water tables you see the properties.

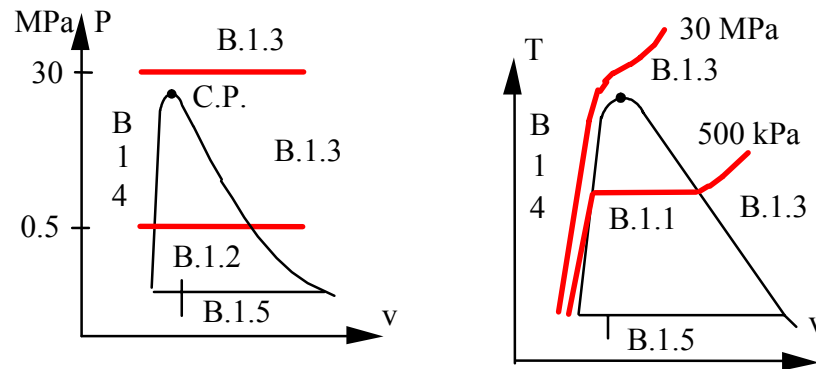

The 30 MPa line in Table B.1.4 starts at 0°C and table ends at 380°C, the line is continued in Table B.1.3 starting at 375°C and table ends at 1300°C.

The 500 kPa line in Table B.1.4 starts at 0.01°C and table ends at the saturated liquid state (151.86°C). The line is continued in Table B.1.3 starting at the saturated vapor state (151.86°C) continuing up to 1300°C.

**3.8**

If I have 1 L ammonia at room pressure and temperature (100 kPa, 20°C) how much mass is that?

Ammonia Tables B.2:

B.2.1  $P_{\text{sat}} = 857.5 \text{ kPa}$  at 20°C so superheated vapor.

B.2.2  $v = 1.4153 \text{ m}^3/\text{kg}$  under subheading 100 kPa

$$m = \frac{V}{v} = \frac{0.001 \text{ m}^3}{1.4153 \text{ m}^3/\text{kg}} = \mathbf{0.000\ 706 \text{ kg} = 0.706 \text{ g}}$$

## 3.9

Locate the state of ammonia at 200 kPa,  $-10^{\circ}\text{C}$ . Indicate in both the P-v and the T-v diagrams the location of the nearest states listed in the printed Table B.2

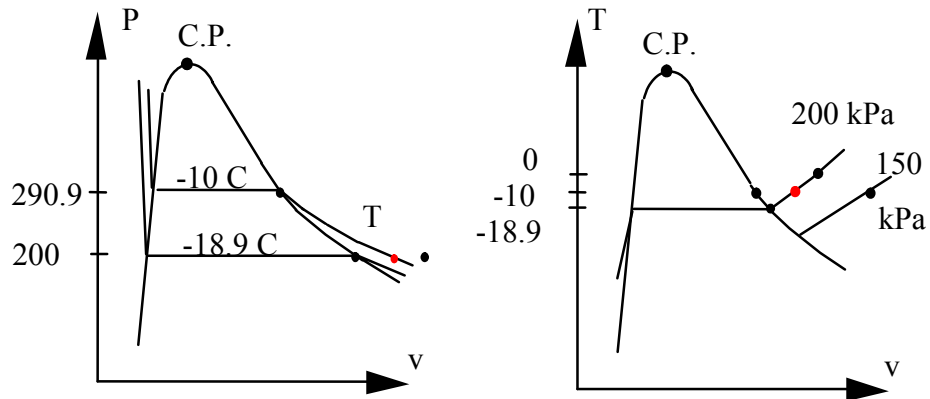

Excerpts from this work may be reproduced by instructors for distribution on a not-for-profit basis for testing or instructional purposes only to students enrolled in courses for which this textbook has been adopted. Any other reproduction or translation of this work beyond that permitted by Sections 107 or 108 of the 1976 United States Copyright Act without the permission of the copyright owner is unlawful.

**3.10**

Why are most of the compressed liquid or solid regions not included in the printed tables?

For the compressed liquid and the solid phases the specific volume and thus density is nearly constant. These surfaces are very steep nearly constant  $v$  and there is then no reason to fill up a table with the same value of  $v$  for different  $P$  and  $T$ .

**3.11**

How does a constant  $v$ -process look like for an ideal gas in a  $P$ - $T$  diagram?

For an ideal gas:  $Pv = RT$  so then  $P = (R/v) T$

Constant  $v$  is a straight line with slope  $(R/v)$  in the  $P$ - $T$  diagram

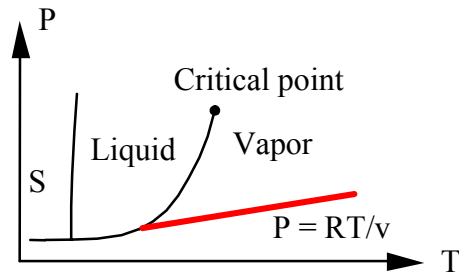



**3.12**

If  $v = RT/P$  for an ideal gas what is the similar equation for a liquid?

The equation for a liquid is:  $v = \text{Constant} = v_o$

If you include that  $v$  increases a little with  $T$  then:  $v = v_o + C(T - T_o)$   
where  $C$  is a small constant.

**3.13**

How accurate (find  $Z$ ) is it to assume propane is an ideal gas a room conditions?

The propane table is not printed in appendix B so to get this information we either must use the computer software or the generalized charts.

From Table A.2  $P_c = 4250 \text{ kPa}$ ,  $T_c = 370 \text{ K}$

The reduced properties:  $P_r = \frac{101}{4250} = 0.024$ ,  $T_r = \frac{293}{370} = 0.792$

From Fig. D.1:  $Z = 0.98$

So it is an ideal gas within 2% accuracy.

A modest pressure natural gas container.



**3.14**

With  $T_r = 0.80$  what is the ratio of  $v_g/v_f$  using Fig. D.1 or Table D.4

Since the two specific volumes are at the same P and T we have

$$Pv_f = Z_f RT \quad \text{and} \quad Pv_g = Z_g RT$$

so the ratio is

$$\frac{v_g}{v_f} = \frac{Z_g}{Z_f} = \frac{0.807}{0.042} = 19.2$$

**3.15**

To solve for  $v$  given  $(P, T)$  in Eq 3.9 what mathematical problem do you have?

From Eq. 3.9 you notice it is non-linear in specific volume. Multiplying through with the common denominator we get an equation cubic in  $v$ . We thus have to find the roots for a cubic equation (zero points in a polynomial of order three). If you have ever seen the exact solution to that you realize it will be easier to solve by trial and error and select the proper root(s) (it cannot be negative).

## Phase Diagrams, Triple and Critical Points

Excerpts from this work may be reproduced by instructors for distribution on a not-for-profit basis for testing or instructional purposes only to students enrolled in courses for which this textbook has been adopted. *Any other reproduction or translation of this work beyond that permitted by Sections 107 or 108 of the 1976 United States Copyright Act without the permission of the copyright owner is unlawful.*

## 3.16

Carbon dioxide at 280 K can be in different phases. Indicate the pressure range you have for each of the three phases (vapor, liquid and solid).

Look at the P-T phase diagram in Fig. 3.6 at 280 K:

$P < 4000 \text{ kPa}$                       vapor  
 $4000 \text{ kPa} < P < 400 \text{ MPa}$         liquid  
 $400 \text{ MPa} < P$                         solid

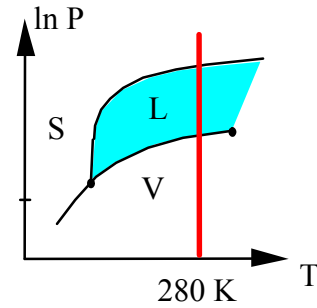

**3.17**

Modern extraction techniques can be based on dissolving material in supercritical fluids such as carbon dioxide. How high are pressure and density of carbon dioxide when the pressure and temperature are around the critical point? Repeat for ethyl alcohol.

Solution:

CO<sub>2</sub> :

Table A.2:  $P_c = 7.38 \text{ MPa}$ ,  $T_c = 304 \text{ K}$ ,  $v_c = 0.00212 \text{ m}^3/\text{kg}$

$$\rho_c = 1/v_c = 1/0.00212 = 472 \text{ kg/m}^3$$

C<sub>2</sub>H<sub>5</sub>OH:

Table A.2:  $P_c = 6.14 \text{ MPa}$ ,  $T_c = 514 \text{ K}$ ,  $v_c = 0.00363 \text{ m}^3/\text{kg}$

$$\rho_c = 1/v_c = 1/0.00363 = 275 \text{ kg/m}^3$$

**3.18**

The ice cap on the North Pole could be 1000 m thick with a density of  $920 \text{ kg/m}^3$ . Find the pressure at the bottom and the corresponding melting temperature.

Solution:

$$\rho_{\text{ICE}} = 920 \text{ kg/m}^3$$

$$\Delta P = \rho g H = 920 \text{ kg/m}^3 \times 9.80665 \text{ m/s}^2 \times 1000 = 9\,022\,118 \text{ Pa}$$

$$P = P_0 + \Delta P = 101.325 + 9022 = \mathbf{9123 \text{ kPa}}$$

See figure 3.7 liquid solid interphase  $\Rightarrow T_{\text{LS}} = -1^\circ\text{C}$

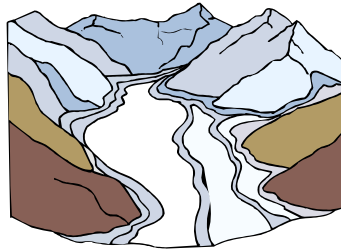



## 3.19

Find the lowest temperature at which it is possible to have water in the liquid phase. At what pressure must the liquid exist?

Solution:

There is no liquid at lower temperatures than on the fusion line, see Fig. 3.7, saturated ice III to liquid phase boundary is at

$$T \approx 263\text{K} \approx -10^\circ\text{C} \text{ and}$$

$$P \approx 210 \text{ MPa}$$

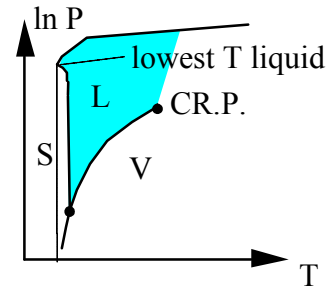

## 3.20

Water at 27°C can exist in different phases dependent upon the pressure. Give the approximate pressure range in kPa for water being in each one of the three phases vapor, liquid or solid.

Solution:

The phases can be seen in Fig. 3.7, a sketch of which is shown to the right.

$$T = 27\text{ }^{\circ}\text{C} = 300\text{ K}$$

From Fig. 3.6:

$$P_{VL} \approx 4 \times 10^{-3}\text{ MPa} = 4\text{ kPa},$$

$$P_{LS} = 10^3\text{ MPa}$$

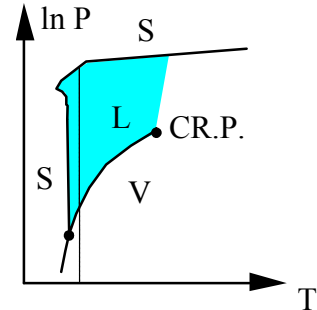

$0 < P < 4\text{ kPa}$	<b>VAPOR</b>
$0.004\text{ MPa} < P < 1000\text{ MPa}$	<b>LIQUID</b>
$P > 1000\text{ MPa}$	<b>SOLID (ICE)</b>

## 3.21

Dry ice is the name of solid carbon dioxide. How cold must it be at atmospheric (100 kPa) pressure? If it is heated at 100 kPa what eventually happens?

Solution:

The phase boundaries are shown in Figure 3.6

At 100 kPa the carbon dioxide is solid if  $T < 190 \text{ K}$

It goes directly to a vapor state without becoming a liquid hence its name.

The 100 kPa is below  
the triple point.

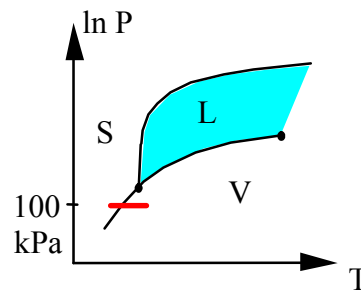

**3.22**

What is the lowest temperature in Kelvin for which you can see metal as a liquid if the metal is *a.* silver *b.* copper

Solution:

Assume the two substances have a phase diagram similar to Fig. 3.6, then we can see the triple point data in Table 3.2

$$T_a = 961^\circ\text{C} = \mathbf{1234\text{ K}}$$

$$T_b = 1083^\circ\text{C} = \mathbf{1356\text{ K}}$$

## 3.23

A substance is at 2 MPa, 17°C in a rigid tank. Using only the critical properties can the phase of the mass be determined if the substance is nitrogen, water or propane?

Solution:

Find state relative to critical point properties which are from Table A.2:

- |             |          |   |           |  |         |
|-------------|----------|---|-----------|--|---------|
| a) Nitrogen | $N_2$    | : | 3.39 MPa  |  | 126.2 K |
| b) Water    | $H_2O$   | : | 22.12 MPa |  | 647.3 K |
| c) Propane  | $C_3H_8$ | : | 4.25 MPa  |  | 369.8 K |

State is at 17 °C = 290 K and 2 MPa <  $P_c$   
for all cases:

$N_2$  :  $T \gg T_c$  Superheated vapor  $P < P_c$

$H_2O$  :  $T \ll T_c$ ;  $P \ll P_c$

you cannot say.

$C_3H_8$  :  $T < T_c$ ;  $P < P_c$  you cannot say

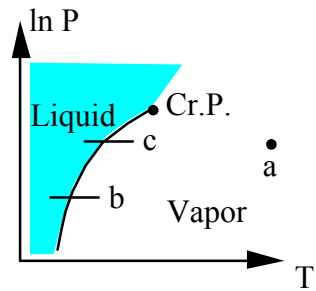

## 3.24

Give the phase for the following states.

Solution:

- a.  $\text{CO}_2$   $T = 40^\circ\text{C}$   $P = 0.5 \text{ MPa}$  Table A.2  
 $T > T_c \Rightarrow$  also  $P \ll P_c$   
**superheated vapor** assume ideal gas Table A.5
- b. Air  $T = 20^\circ\text{C}$   $P = 200 \text{ kPa}$  Table A.2  
**superheated vapor** assume ideal gas Table A.5
- c.  $\text{NH}_3$   $T = 170^\circ\text{C}$   $P = 600 \text{ kPa}$  Table B.2.2 or A.2  
 $T > T_c \Rightarrow$  **superheated vapor**

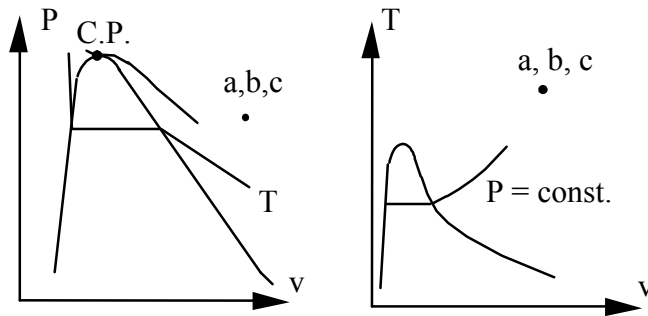

## General Tables

Excerpts from this work may be reproduced by instructors for distribution on a not-for-profit basis for testing or instructional purposes only to students enrolled in courses for which this textbook has been adopted. *Any other reproduction or translation of this work beyond that permitted by Sections 107 or 108 of the 1976 United States Copyright Act without the permission of the copyright owner is unlawful.*

## 3.25

Give the phase for the following states.

Solution:

a.  $\text{H}_2\text{O}$   $T = 260^\circ\text{C}$   $P = 5 \text{ MPa}$  Table B.1.1 or B.1.2

B.1.1 For given  $T$  read:  $P_{\text{sat}} = 4.689 \text{ MPa}$

$P > P_{\text{sat}} \Rightarrow$  **compressed liquid**

B.1.2 For given  $P$  read:  $T_{\text{sat}} = 264^\circ\text{C}$

$T < T_{\text{sat}} \Rightarrow$  **compressed liquid**

b.  $\text{H}_2\text{O}$   $T = -2^\circ\text{C}$   $P = 100 \text{ kPa}$  Table B.1.1  $T < T_{\text{triple point}}$

Table B.1.5 at  $-2^\circ\text{C}$  read:  $P_{\text{sat}} = 0.518 \text{ kPa}$

since  $P > P_{\text{sat}} \Rightarrow$  **compressed solid**

Note state b in P-v, see the 3-D figure, is up on the solid face.

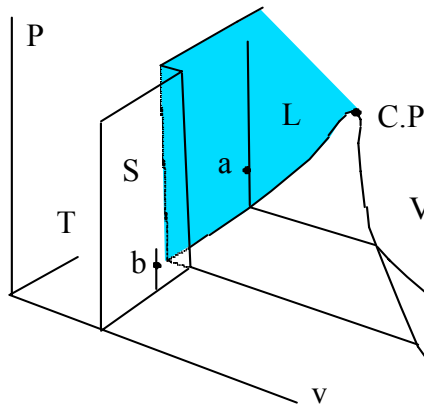
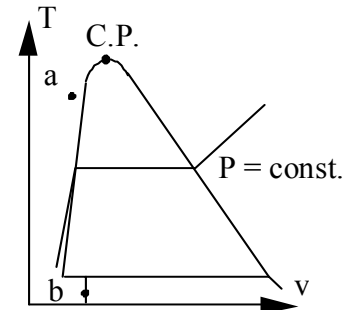
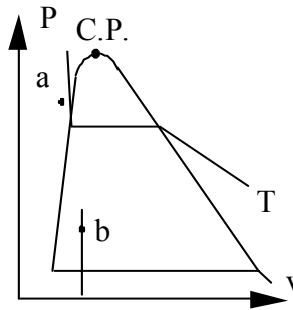

Excerpts from this work may be reproduced by instructors for distribution on a not-for-profit basis for testing or instructional purposes only to students enrolled in courses for which this textbook has been adopted. Any other reproduction or translation of this work beyond that permitted by Sections 107 or 108 of the 1976 United States Copyright Act without the permission of the copyright owner is unlawful.



## 3.26

Determine the phase of the substance at the given state using Appendix B tables

- a) Water            100°C, 500 kPa
- b) Ammonia        -10°C, 150 kPa
- c) R-410a           0°C, 350 kPa

Solution:

- a) From Table B.1.1     $P_{\text{sat}}(100^\circ\text{C}) = 101.3 \text{ kPa}$

500 kPa >  $P_{\text{sat}}$  then it is compressed liquid

OR from Table B.1.2     $T_{\text{sat}}(500 \text{ kPa}) = 152^\circ\text{C}$

$100^\circ\text{C} < T_{\text{sat}}$  then it is subcooled liquid = compressed liquid

- b) Ammonia  $\text{NH}_3$  :

Table B.2.1:  $P < P_{\text{sat}}(-10^\circ\text{C}) = 291 \text{ kPa}$

Superheated vapor

- c) R-410a

Table B.4.1:  $P < P_{\text{sat}}(0^\circ\text{C}) = 799 \text{ kPa}$

Superheated vapor.

The S-L fusion line goes slightly to the left for water. It tilts slightly to the right for most other substances.

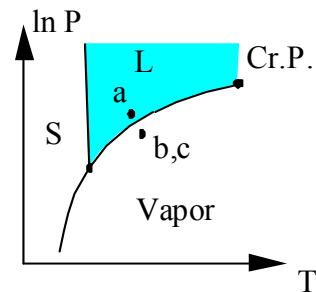

## 3.27

Determine whether water at each of the following states is a compressed liquid, a superheated vapor, or a mixture of saturated liquid and vapor.

- |    |                                                       |    |                                    |
|----|-------------------------------------------------------|----|------------------------------------|
| a. | $P = 10 \text{ MPa}, v = 0.003 \text{ m}^3/\text{kg}$ | b. | $1 \text{ MPa}, 190^\circ\text{C}$ |
| c. | $200^\circ\text{C}, 0.1 \text{ m}^3/\text{kg}$        | d. | $10 \text{ kPa}, 10^\circ\text{C}$ |

Solution:

For all states start search in table B.1.1 (if T given) or B.1.2 (if P given)

- a.  $P = 10 \text{ MPa}, v = 0.003 \text{ m}^3/\text{kg}$  so look in B.1.2 at 10 MPa  
 $v_f = 0.001452; v_g = 0.01803 \text{ m}^3/\text{kg},$   
 $\Rightarrow v_f < v < v_g \Rightarrow$  so mixture of liquid and vapor.
- b.  $1 \text{ MPa}, 190^\circ\text{C}$  : Only one of the two look-ups is needed  
 B.1.1:  $P < P_{\text{sat}} = 1254.4 \text{ kPa}$  so it is superheated vapor  
 B.1.2:  $T > T_{\text{sat}} = 179.91^\circ\text{C}$  so it is superheated vapor
- c.  $200^\circ\text{C}, 0.1 \text{ m}^3/\text{kg}$ : look in B.1.1  
 $v_f = 0.001156 \text{ m}^3/\text{kg} ; v_g = 0.12736 \text{ m}^3/\text{kg},$   
 $\Rightarrow v_f < v < v_g \Rightarrow$  so mixture of liquid and vapor.
- d.  $10 \text{ kPa}, 10^\circ\text{C}$  : Only one of the two look-ups is needed  
 From B.1.1:  $P > P_g = 1.2276 \text{ kPa}$  so compressed liquid  
 From B.1.2:  $T < T_{\text{sat}} = 45.8^\circ\text{C}$  so compressed liquid

States shown are placed relative to the two-phase region, not to each other.

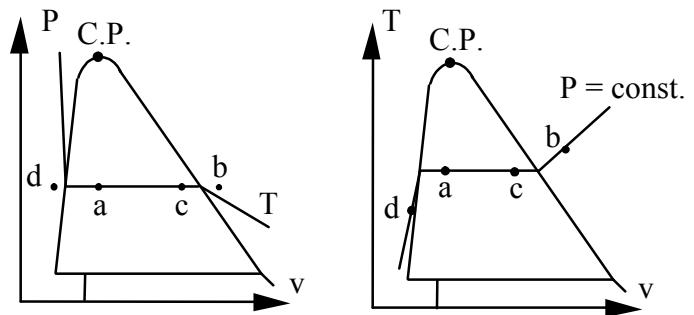

**3.28**

For water at 100 kPa with a quality of 10%, find the volume fraction of vapor.

This is a two-phase state at a given pressure:

$$\text{Table B.1.2: } v_f = 0.001\,043 \text{ m}^3/\text{kg}, \quad v_g = 1.6940 \text{ m}^3/\text{kg}$$

From the definition of quality we get the masses from total mass,  $m$ , as

$$m_f = (1 - x) m, \quad m_g = x m$$

The volumes are

$$V_f = m_f v_f = (1 - x) m v_f, \quad V_g = m_g v_g = x m v_g$$

So the volume fraction of vapor is

$$\begin{aligned} \text{Fraction} &= \frac{V_g}{V} = \frac{V_g}{V_g + V_f} = \frac{x m v_g}{x m v_g + (1 - x) m v_f} \\ &= \frac{0.1 \times 1.694}{0.1 \times 1.694 + 0.9 \times 0.001043} = \frac{0.1694}{0.17034} = \mathbf{0.9945} \end{aligned}$$

Notice that the liquid volume is only about 0.5% of the total. We could also have found the overall  $v = v_f + x v_{fg}$  and then  $V = m v$ .

## 3.29

Determine whether refrigerant R-410a in each of the following states is a compressed liquid, a superheated vapor, or a mixture of saturated liquid and vapor.

Solution:

All cases are seen in Table B.4.1

- a.  $50^\circ\text{C}$ ,  $0.05\text{ m}^3/\text{kg}$  From table B.4.1 at  $50^\circ\text{C}$   $v_g = 0.00707\text{ m}^3/\text{kg}$   
since  $v > v_g$  we have **superheated vapor**
- b.  $1.0\text{ MPa}$ ,  $20^\circ\text{C}$  From table B.4.1 at  $20^\circ\text{C}$   $P_g = 909.9\text{ kPa}$   
since  $P < P_g$  we have **superheated vapor**
- c.  $0.1\text{ MPa}$ ,  $0.1\text{ m}^3/\text{kg}$  From table B.4.1 at  $0.1\text{ MPa}$  (use  $101\text{ kPa}$ )  
 $v_f = 0.00074$  and  $v_g = 0.2395\text{ m}^3/\text{kg}$   
as  $v_f < v < v_g$  we have a **mixture of liquid & vapor**
- d.  $-20^\circ\text{C}$ ,  $200\text{ kPa}$  **superheated vapor**,  $P < P_g = 400\text{ kPa}$  at  $-20^\circ\text{C}$

## 3.30

Place the states in Problem 3.29 in a sketch of the P-v diagram.

States shown are placed relative to the two-phase region, not to each other.

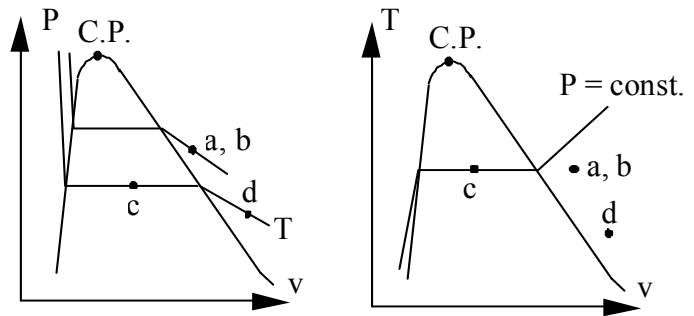

## 3.31

Refer to Fig. 3.18. How much is the change in liquid specific volume for water at 20°C as you move up from state i towards state j reaching 15 000 kPa?

State “i”, here “a”, is saturated liquid and up is then compressed liquid states

a	Table B.1.1:	$v_f = 0.001\ 002\ \text{m}^3/\text{kg}$	at	2.34 kPa
b	Table B.1.4:	$v_f = 0.001\ 002\ \text{m}^3/\text{kg}$	at	500 kPa
c	Table B.1.4:	$v_f = 0.001\ 001\ \text{m}^3/\text{kg}$	at	2000 kPa
d	Table B.1.4:	$v_f = 0.001\ 000\ \text{m}^3/\text{kg}$	at	5000 kPa
e	Table B.1.4:	$v_f = 0.000\ 995\ \text{m}^3/\text{kg}$	at	15 000 kPa
f	Table B.1.4:	$v_f = 0.000\ 980\ \text{m}^3/\text{kg}$	at	50 000 kPa

Notice how small the changes in  $v$  are for very large changes in  $P$ .

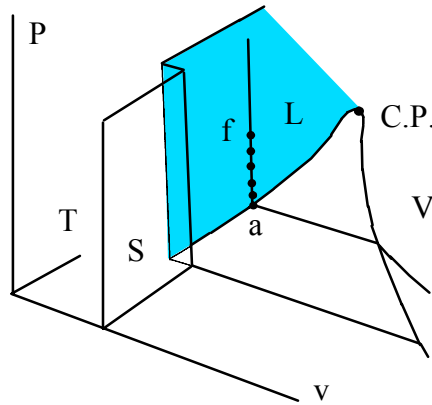
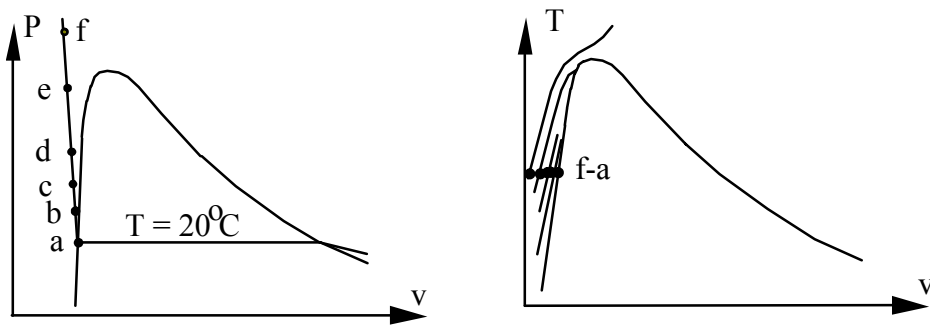

Excerpts from this work may be reproduced by instructors for distribution on a not-for-profit basis for testing or instructional purposes only to students enrolled in courses for which this textbook has been adopted. *Any other reproduction or translation of this work beyond that permitted by Sections 107 or 108 of the 1976 United States Copyright Act without the permission of the copyright owner is unlawful.*

## 3.32

Fill out the following table for substance ammonia:

Solution:

	P [kPa]	T [°C]	v [m <sup>3</sup> /kg]	x
a)	<b>1200</b>	50	0.1185	<b>Undefined</b>
b)	<b>2033</b>	50	<b>0.0326</b>	0.5

a) B.2.1  $v > v_g \Rightarrow$  superheated vapor Look in B.2.2

b) B.2.1  $P = P_{\text{sat}} = 2033 \text{ kPa}$

$$v = v_f + x v_{fg} = 0.001777 + 0.5 \times 0.06159 = 0.0326 \text{ m}^3/\text{kg}$$

## 3.33

Place the two states a-b listed in Problem 3.32 as labeled dots in a sketch of the P-v and T-v diagrams.

Solution:

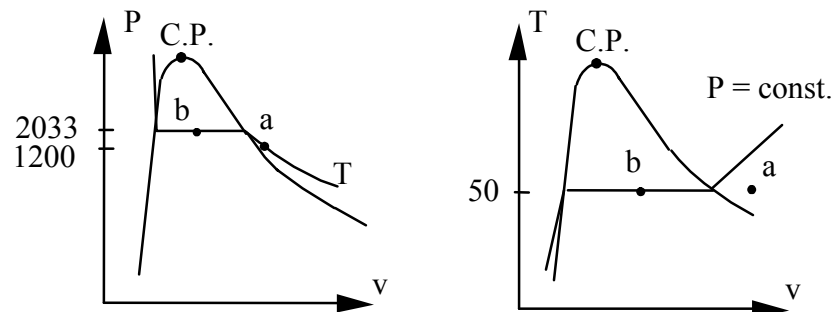

## 3.34

Give the phase and the missing property of  $P$ ,  $T$ ,  $v$  and  $x$ .

a. R-134a  $T = -20^\circ\text{C}$ ,  $P = 150 \text{ kPa}$

b. R-134a  $P = 300 \text{ kPa}$ ,  $v = 0.072 \text{ m}^3/\text{kg}$

Solution:

a) B.5.1  $P > P_{\text{sat}} = 133.7 \text{ kPa} \Rightarrow$  **compressed liquid**

$$v \sim v_f = 0.000738 \text{ m}^3/\text{kg}$$

$$x = \text{undefined}$$

b) B.5.2  $v > v_g$  at  $300 \text{ kPa} \Rightarrow$  **superheated vapor**

$$T = 10 + (20 - 10) \left( \frac{0.072 - 0.07111}{0.07441 - 0.07111} \right) = 12.7^\circ\text{C}$$

$$x = \text{undefined}$$

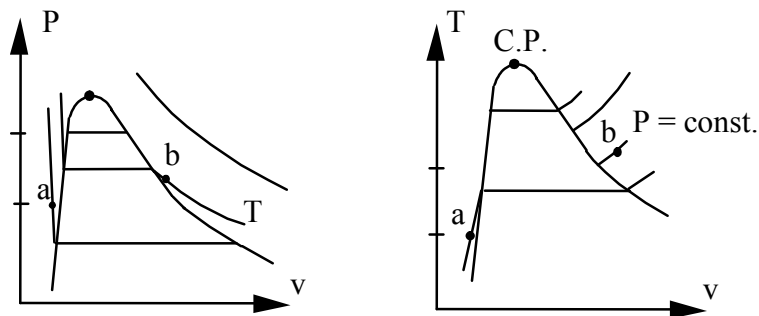

## 3.35

Fill out the following table for substance water:

Solution:

	P [kPa]	T [°C]	v [m <sup>3</sup> /kg]	x
a)	500	20	<b>0.001002</b>	<b>Undefined</b>
b)	500	<b>151.86</b>	0.20	<b>0.532</b>
c)	1400	200	<b>0.14302</b>	<b>Undefined</b>
d)	<b>8581</b>	300	<b>0.01762</b>	0.8

a) Table B.1.1  $P > P_{\text{sat}}$  so it is compressed liquid  $\Rightarrow$  Table B.1.4

b) Table B.1.2  $v_f < v < v_g$  so two phase L + V

$$x = \frac{v - v_f}{v_{fg}} = (0.2 - 0.001093) / 0.3738 = 0.532$$

$$T = T_{\text{sat}} = 151.86^\circ\text{C}$$

c) Only one of the two look-up is needed

Table B.1.1 200°C  $P < P_{\text{sat}} =$   $\Rightarrow$  superheated vapor

Table B.1.2 1400 kPa  $T > T_{\text{sat}} = 195^\circ\text{C}$

Table B.1.3 sub-table for 1400 kPa gives the state properties

d) Table B.1.1 since quality is given it is two-phase

$$v = v_f + x \times v_{fg} = 0.001404 + 0.8 \times 0.02027 = 0.01762 \text{ m}^3/\text{kg}$$

## 3.36

Place the four states a-d listed in Problem 3.35 as labeled dots in a sketch of the P-v and T-v diagrams.

Solution:

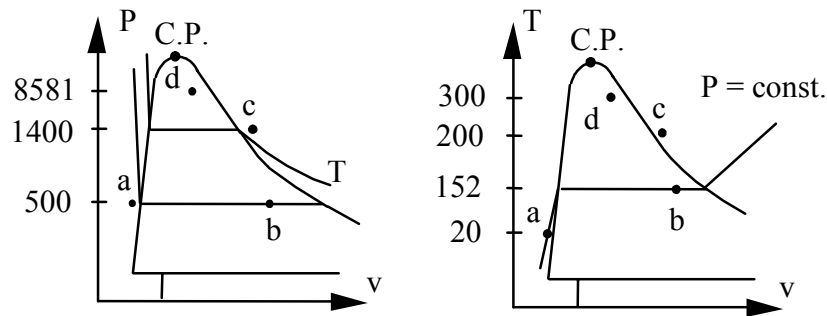

Excerpts from this work may be reproduced by instructors for distribution on a not-for-profit basis for testing or instructional purposes only to students enrolled in courses for which this textbook has been adopted. Any other reproduction or translation of this work beyond that permitted by Sections 107 or 108 of the 1976 United States Copyright Act without the permission of the copyright owner is unlawful.



## 3.37

Determine the specific volume for R-410a at these states:

- a.  $-15^{\circ}\text{C}$ , 500 kPa
- b.  $20^{\circ}\text{C}$ , 1000 kPa
- c.  $20^{\circ}\text{C}$ , quality 25%

a) Table B.4.1:  $P > P_{\text{sat}} = 480.4 \text{ kPa}$ , so compressed liquid.  
 $v \approx v_f = 0.000815 \text{ m}^3/\text{kg}$

b) Table B.4.1:  $P < P_{\text{sat}} = 1444 \text{ kPa}$ , so superheated vapor  
Table B.4.2:  $v = 0.02838 \text{ m}^3/\text{kg}$

c) Table B.4.1:  $v_f = 0.000815 \text{ m}^3/\text{kg}$ ,  $v_{fg} = 0.01666 \text{ m}^3/\text{kg}$  so

$$v = v_f + x v_{fg} = 0.000815 + 0.25 \times 0.01666 = 0.00498 \text{ m}^3/\text{kg}$$

## 3.38

Give the missing property of  $P$ ,  $T$ ,  $v$  and  $x$  for  $\text{CH}_4$  at:

- a.  $T = 155 \text{ K}$ ,  $v = 0.04 \text{ m}^3/\text{kg}$   
 b.  $T = 350 \text{ K}$ ,  $v = 0.25 \text{ m}^3/\text{kg}$

a) B.7.1  $v < v_g = 0.04892 \text{ m}^3/\text{kg} \Rightarrow$  2-phase

$$x = \frac{v - v_f}{v_{fg}} = \frac{0.04 - 0.002877}{0.04605} = \mathbf{0.806}$$

$$P = P_{\text{sat}} = \mathbf{1296 \text{ kPa}}$$

b) B.7.1  $T > T_c$  and  $v \gg v_c \Rightarrow$  superheated vapor B.7.2  
 located between 600 & 800 kPa

$$P = 600 + 200 \frac{0.25 - 0.30067}{0.2251 - 0.30067} = \mathbf{734 \text{ kPa}}$$

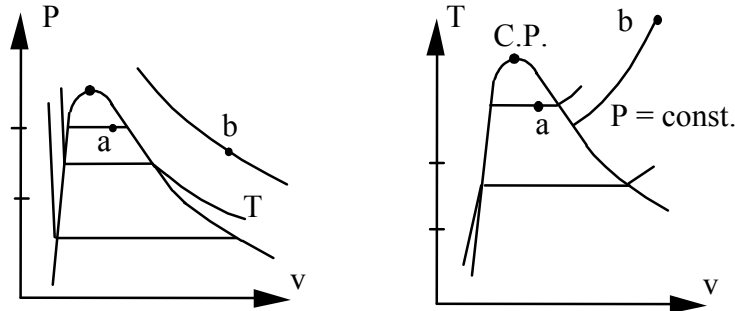

## 3.39

Give the specific volume of carbon-dioxide at  $-20^{\circ}\text{C}$  for 2000 kPa and repeat for 1400 kPa.

Table B.3.1:  $-20^{\circ}\text{C}$   $P_{\text{sat}} = 1969 \text{ kPa}$ ,

at 2000 kPa state is compressed liquid:  $v = v_f = 0.000969 \text{ m}^3/\text{kg}$

at 1400 kPa state is superheated vapor:  $v = 0.0296 \text{ m}^3/\text{kg}$

The 2000 kPa is above and the 1400 kPa is below the vaporization line.

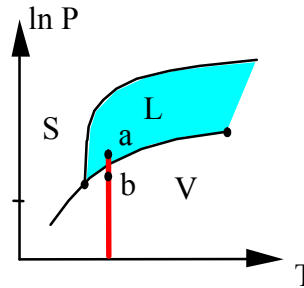

**3.40**

Calculate the following specific volumes

- a. CO<sub>2</sub>            10°C, 80% quality
- b. Water            4 MPa, 90% quality
- c. Nitrogen        120 K, 60% quality

Solution:

All states are two-phase with quality given. The overall specific volume is given by Eq.3.1 or 3.2

$$v = v_f + x v_{fg} = (1-x)v_f + x v_g$$

- a. CO<sub>2</sub>            10°C, 80% quality in Table B.3.1

$$v = 0.001161 + x \times 0.00624 = 0.006153 \text{ m}^3/\text{kg}$$

- b. Water            4 MPa, 90% quality in Table B.1.2

$$v = 0.001252(1-x) + x \times 0.04978 = 0.04493 \text{ m}^3/\text{kg}$$

- c. Nitrogen        120 K, 60% quality in Table B.6.1

$$v = 0.001915 + x \times 0.00608 = 0.005563 \text{ m}^3/\text{kg}$$

## 3.41

Give the phase and  $P$ ,  $x$  for nitrogen at:

- a)  $T = 120 \text{ K}$ ,  $v = 0.006 \text{ m}^3/\text{kg}$   
 b)  $T = 140 \text{ K}$ ,  $v = 0.002 \text{ m}^3/\text{kg}$

Solution:

- a) Table B.6.1  $v < v_g = 0.00799 \text{ m}^3/\text{kg}$  so state is two-phase L + V  
 $P = P_{\text{sat}} = \mathbf{2513 \text{ kPa}}$

$$x = \frac{v - v_f}{v_{fg}} = (0.006 - 0.001915)/0.00608 = \mathbf{0.6719}$$

- b) Table B.6.1  $T > T_c = 126.2 \text{ K}$  so go to B.6.2 superheated vapor.  
 Look at any entry for 140 K then you see a too large  $v$  meaning  $P$  is higher. Last one  
 $P = \mathbf{10\,000 \text{ kPa}}$ ,  $x = \mathbf{\text{undefined}}$

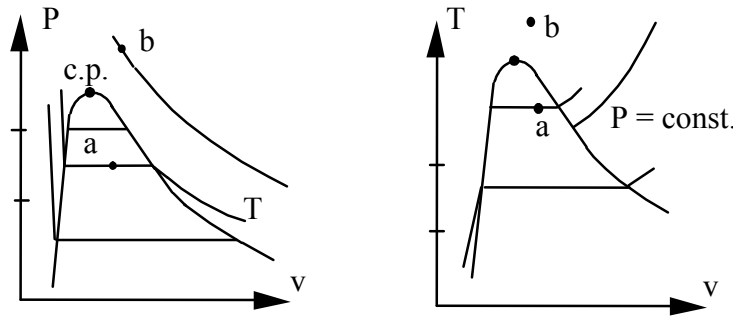

## 3.42

You want a pot of water to boil at  $105^{\circ}\text{C}$ . How heavy a lid should you put on the 15 cm diameter pot when  $P_{\text{atm}} = 101 \text{ kPa}$ ?

Solution:

$$\text{Table B.1.1 at } 105^{\circ}\text{C} : \quad P_{\text{sat}} = 120.8 \text{ kPa}$$

$$A = \frac{\pi}{4} D^2 = \frac{\pi}{4} 0.15^2 = 0.01767 \text{ m}^2$$

$$F_{\text{net}} = (P_{\text{sat}} - P_{\text{atm}}) A = (120.8 - 101) \text{ kPa} \times 0.01767 \text{ m}^2 \\ = 0.3498 \text{ kN} = 350 \text{ N}$$

$$F_{\text{net}} = m_{\text{lid}} g$$

$$m_{\text{lid}} = F_{\text{net}}/g = \frac{350}{9.807} = \mathbf{35.7 \text{ kg}}$$

Some lids are clamped on, the problem deals with one that stays on due to its weight.

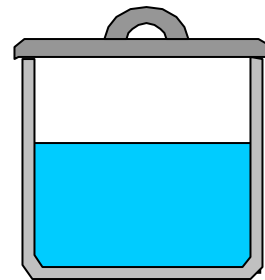
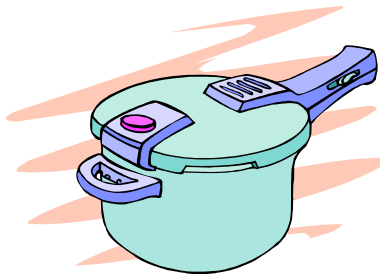

## 3.43

Water at 120°C with a quality of 25% has its temperature raised 20°C in a constant volume process. What is the new quality and pressure?

Solution:

State 1 from Table B.1.1 at 120°C

$$v = v_f + x v_{fg} = 0.001060 + 0.25 \times 0.8908 = 0.22376 \text{ m}^3/\text{kg}$$

State 2 has same  $v$  at 140°C also from Table B.1.1

$$x = \frac{v - v_f}{v_{fg}} = \frac{0.22376 - 0.00108}{0.50777} = \mathbf{0.4385}$$

$$P = P_{\text{sat}} = \mathbf{361.3 \text{ kPa}}$$

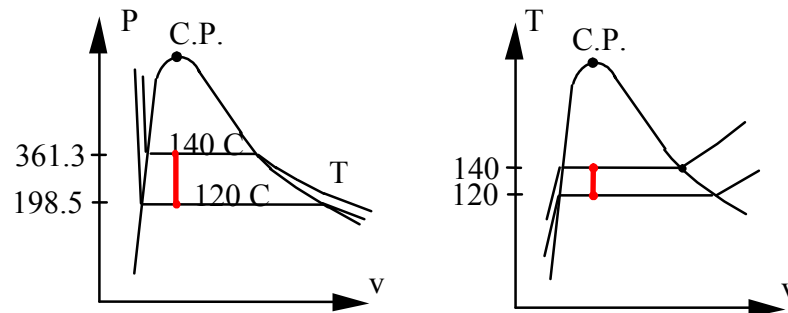

## 3.44

A sealed rigid vessel has volume of  $1 \text{ m}^3$  and contains  $2 \text{ kg}$  of water at  $100^\circ\text{C}$ . The vessel is now heated. If a safety pressure valve is installed, at what pressure should the valve be set to have a maximum temperature of  $200^\circ\text{C}$ ?

Solution:

Process:  $v = V/m = \text{constant}$

State 1:  $v_1 = 1/2 = 0.5 \text{ m}^3/\text{kg}$   
 from Table B.1.1  
 it is 2-phase

State 2:  $200^\circ\text{C}$ ,  $0.5 \text{ m}^3/\text{kg}$   
 Table B.1.3 between 400  
 and 500 kPa so interpolate

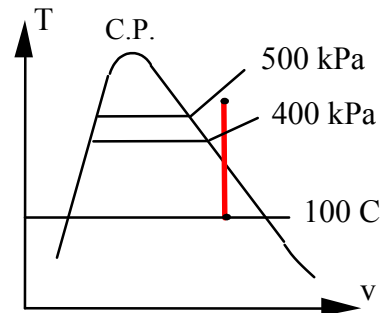

$$P \cong 400 + \frac{0.5 - 0.53422}{0.42492 - 0.53422} \times (500 - 400) = \mathbf{431.3 \text{ kPa}}$$



## 3.45

Saturated water vapor at 200 kPa is in a constant pressure piston cylinder. At this state the piston is 0.1 m from the cylinder bottom. How much is this distance and the temperature if the water is cooled to occupy half the original volume?

Solution:

State 1: B.1.2  $v_1 = v_g(200 \text{ kPa}) = 0.8857 \text{ m}^3/\text{kg}$ ,  $T_1 = 120.2^\circ\text{C}$

Process:  $P = \text{constant} = 200 \text{ kPa}$

State 2:  $P$ ,  $v_2 = v_1/2 = 0.44285 \text{ m}^3/\text{kg}$

Table B.1.2  $v_2 < v_g$  so two phase  $T_2 = T_{\text{sat}} = 120.2^\circ\text{C}$

Height is proportional to volume

$$h_2 = h_1 \times v_2/v_1 = 0.1 \times 0.5 = \mathbf{0.05\text{m}}$$

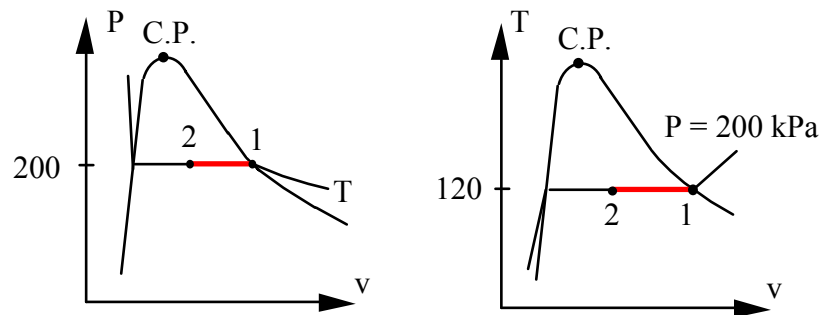

## 3.46

Saturated liquid water at  $60^\circ\text{C}$  is put under pressure to decrease the volume by 1% keeping the temperature constant. To what pressure should it be compressed?

Solution:

State 1:  $T = 60^\circ\text{C}$ ,  $x = 0.0$ ; Table B.1.1:  $v = 0.001017 \text{ m}^3/\text{kg}$

Process:  $T = \text{constant} = 60^\circ\text{C}$

State 2:  $T, v = 0.99 \times v_f(60^\circ\text{C}) = 0.99 \times 0.001017 = 0.0010068 \text{ m}^3/\text{kg}$

Between 20 & 30 MPa in Table B.1.4,  $P \cong \mathbf{23.8 \text{ MPa}}$

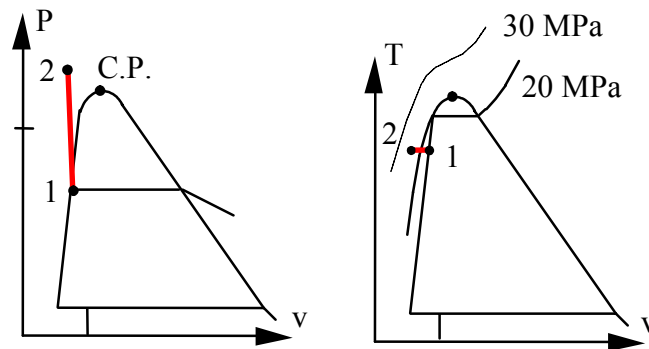

## 3.47

Water at 200 kPa with a quality of 25% has its temperature raised 20°C in a constant pressure process. What is the new quality and volume?

Solution:

State 1 from Table B.1.2 at 200 kPa

$$v = v_f + x v_{fg} = 0.001061 + 0.25 \times 0.88467 = 0.22223 \text{ m}^3/\text{kg}$$

State 2 has same P from Table B.1.2 at 200 kPa

$$T_2 = T_{\text{sat}} + 20 = 120.23 + 20 = 140.23^\circ\text{C}$$

so state is superheated vapor

$x = \text{undefined}$

$$v_2 = 0.88573 + (0.95964 - 0.88573) \frac{20}{150 - 120.23} = \mathbf{0.9354 \text{ m}^3/\text{kg}}$$

Interpolate between the saturated vapor state (the first entry in table B.1.3 for 200 kPa) and the 150°C superheated vapor state also at 200 kPa.

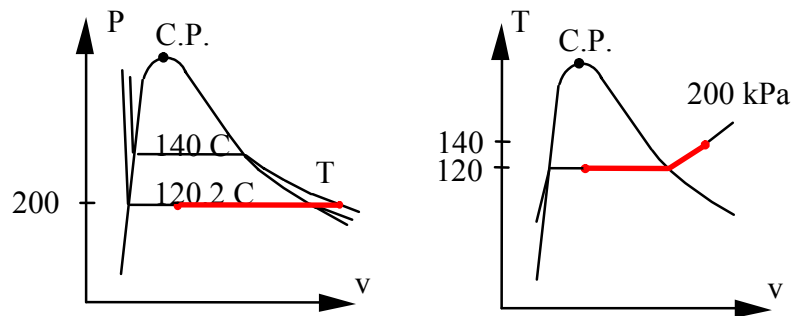

## 3.48

In your refrigerator the working substance evaporates from liquid to vapor at  $-20^{\circ}\text{C}$  inside a pipe around the cold section. Outside (on the back or below) is a black grille inside which the working substance condenses from vapor to liquid at  $+40^{\circ}\text{C}$ . For each location find the pressure and the change in specific volume ( $v$ ) if the substance is ammonia.

Solution:

The properties come from the saturated tables where each phase change takes place at constant pressure and constant temperature.

Substance	TABLE	T	$P_{\text{sat}}$ , kPa	$\Delta v = v_{\text{fg}}$ , $\text{m}^3/\text{kg}$
Ammonia	B.2.1	$40^{\circ}\text{C}$	1555	0.0814
Ammonia	B.2.1	$-20^{\circ}\text{C}$	190	0.622

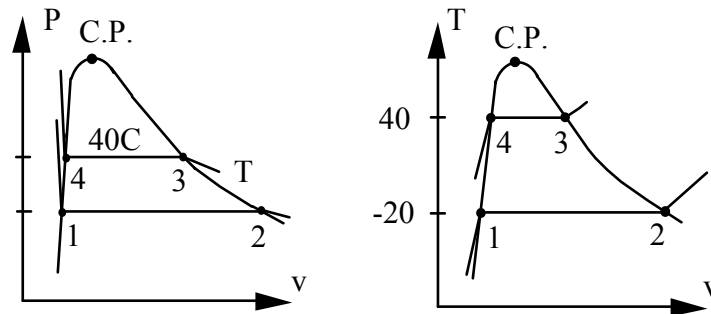

Excerpts from this work may be reproduced by instructors for distribution on a not-for-profit basis for testing or instructional purposes only to students enrolled in courses for which this textbook has been adopted. Any other reproduction or translation of this work beyond that permitted by Sections 107 or 108 of the 1976 United States Copyright Act without the permission of the copyright owner is unlawful.

## 3.49

Repeat the previous problem with the substances

- a) R-134a      b) R-410a

In your refrigerator, the working substance evaporates from liquid to vapor at  $-20^\circ\text{C}$  inside a pipe around the cold section. Outside (on the back or below) is a black grille inside which the working substance condenses from vapor to liquid at  $+40^\circ\text{C}$ . For each location find the pressure and the change in specific volume ( $v$ ).

Solution:

The properties come from the saturated tables where each phase change takes place at constant pressure and constant temperature.

Substance	TABLE	T	$P_{\text{sat}}$ , kPa	$\Delta v = v_{\text{fg}}$ , $\text{m}^3/\text{kg}$
R-134a	B.5.1	$40^\circ\text{C}$	1017	0.019
R-134a	B.5.1	$-20^\circ\text{C}$	134	0.146
R-410a	B.4.1	$40^\circ\text{C}$	2421	0.00865
R-410a	B.4.1	$-20^\circ\text{C}$	400	0.064

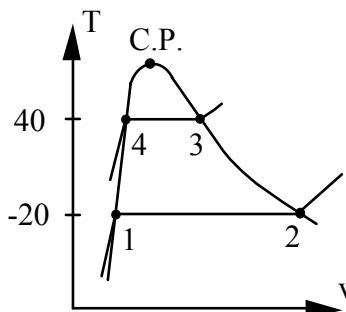
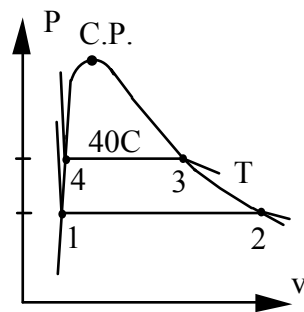

## 3.50

Repeat Problem 3.48 with  $\text{CO}_2$ , condenser at  $+20^\circ\text{C}$  and evaporator at  $-30^\circ\text{C}$ .

Solution:

The properties come from the saturated tables where each phase change takes place at constant pressure and constant temperature.

Substance	TABLE	T	$P_{\text{sat}}$ , kPa	$\Delta v = v_{\text{fg}}$
$\text{CO}_2$	B.3.1	$20^\circ\text{C}$	5729	0.00386
$\text{CO}_2$	B.3.1	$-30^\circ\text{C}$	1428	0.026

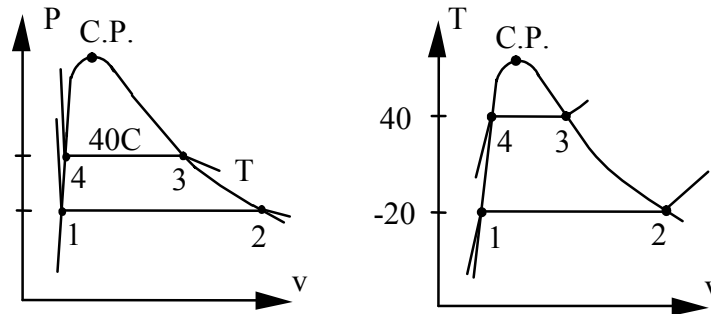

## 3.51

A glass jar is filled with saturated water at 500 kPa, quality 25%, and a tight lid is put on. Now it is cooled to  $-10^{\circ}\text{C}$ . What is the mass fraction of solid at this temperature?

Solution:

$$\text{Constant volume and mass} \Rightarrow v_1 = v_2 = V/m$$

$$\text{From Table B.1.2:} \quad v_1 = 0.001093 + 0.25 \times 0.3738 = 0.094543$$

$$\text{From Table B.1.5:} \quad v_2 = 0.0010891 + x_2 \times 446.756 = v_1 = 0.094543$$

$$\Rightarrow x_2 = 0.0002 \text{ mass fraction vapor}$$

$$x_{\text{solid}} = 1 - x_2 = 0.9998 \quad \text{or} \quad \mathbf{99.98\%}$$

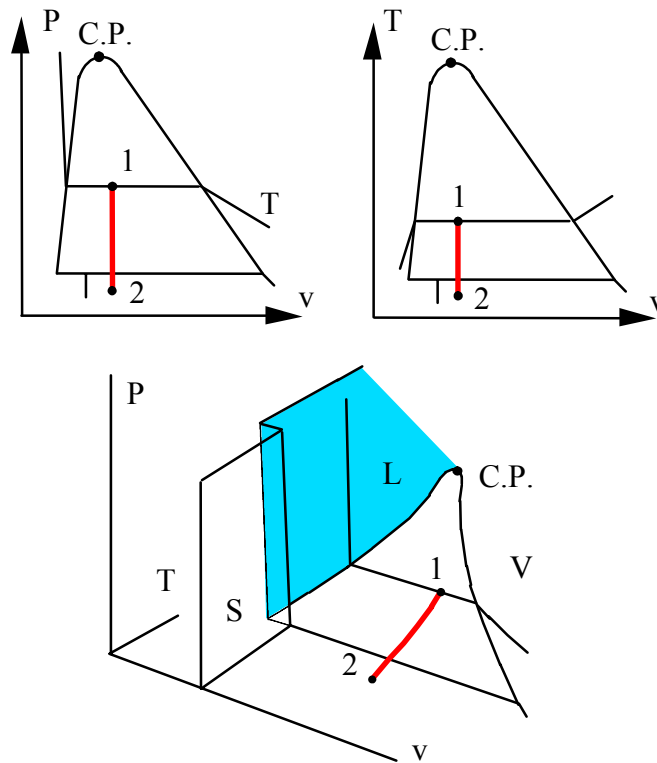

Excerpts from this work may be reproduced by instructors for distribution on a not-for-profit basis for testing or instructional purposes only to students enrolled in courses for which this textbook has been adopted. Any other reproduction or translation of this work beyond that permitted by Sections 107 or 108 of the 1976 United States Copyright Act without the permission of the copyright owner is unlawful.

## 3.52

Two tanks are connected as shown in Fig. P3.52, both containing water. Tank A is at 200 kPa,  $v = 0.5 \text{ m}^3/\text{kg}$ ,  $V_A = 1 \text{ m}^3$  and tank B contains 3.5 kg at 0.5 MPa,  $400^\circ\text{C}$ . The valve is now opened and the two come to a uniform state. Find the final specific volume.

Solution:

Control volume: both tanks. Constant total volume and mass process.

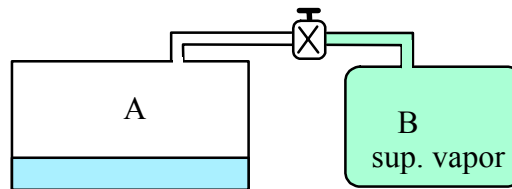

$$\text{State A1: (P, } v) \quad m_A = V_A/v_A = 1/0.5 = 2 \text{ kg}$$

$$\text{State B1: (P, T) Table B.1.3} \quad v_B = 0.6173 \text{ m}^3/\text{kg}$$

$$\Rightarrow V_B = m_B v_B = 3.5 \times 0.6173 = 2.1606 \text{ m}^3$$

$$\text{Final state:} \quad m_{\text{tot}} = m_A + m_B = 5.5 \text{ kg}$$

$$V_{\text{tot}} = V_A + V_B = 3.1606 \text{ m}^3$$

$$v_2 = V_{\text{tot}}/m_{\text{tot}} = \mathbf{0.5746 \text{ m}^3/\text{kg}}$$



## 3.53

Saturated vapor R-134a at 50°C changes volume at constant temperature. Find the new pressure, and quality if saturated, if the volume doubles. Repeat the question for the case the volume is reduced to half the original volume.

Solution:

1: (T, x) B.4.1:  $v_1 = v_g = 0.01512 \text{ m}^3/\text{kg}$ ,  $P_1 = P_{\text{sat}} = 1318 \text{ kPa}$

2:  $v_2 = 2v_1 = 0.03024 \text{ m}^3/\text{kg}$  superheated vapor  
Interpolate between 600 kPa and 800 kPa  
$$P_2 = 600 + 200 \times \frac{0.03024 - 0.03974}{0.02861 - 0.03974} = 771 \text{ kPa}$$

3:  $v_3 = v_1/2 = 0.00756 \text{ m}^3/\text{kg} < v_g$ : two phase  
$$x_3 = \frac{v_3 - v_f}{v_{fg}} = \frac{0.00756 - 0.000908}{0.01422} = 0.4678$$
  
 $P_3 = P_{\text{sat}} = 1318 \text{ kPa}$

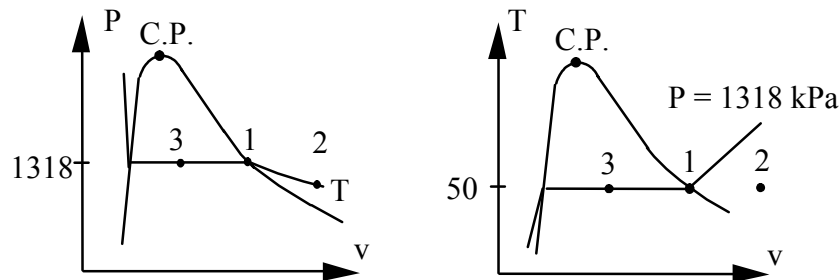

## 3.54

A steel tank contains 6 kg of propane (liquid + vapor) at 20°C with a volume of 0.015 m<sup>3</sup>. The tank is now slowly heated. Will the liquid level inside eventually rise to the top or drop to the bottom of the tank? What if the initial mass is 1 kg instead of 6 kg?

Solution:

Constant volume and mass  $v_2 = v_1 = \frac{V}{m} = \frac{0.015 \text{ m}^3}{6 \text{ kg}} = 0.0025 \text{ m}^3/\text{kg}$

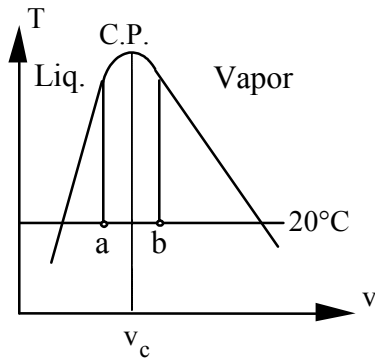

A.2:  $v_c = 0.00454 \text{ m}^3/\text{kg} > v_1$   
eventually reaches sat. liquid.  
 $\Rightarrow$  **level rises to top**

If  $m = 1 \text{ kg} \Rightarrow v_1 = 0.015 \text{ m}^3/\text{kg} > v_c$   
then it will reach saturated vapor.  
 $\Rightarrow$  **level falls**

## 3.55

Saturated water vapor at 60°C has its pressure decreased to increase the volume by 10% keeping the temperature constant. To what pressure should it be expanded?

Solution:

Initial state:  $v = 7.6707 \text{ m}^3/\text{kg}$  from table B.1.1

Final state:  $v = 1.10 \times v_g = 1.1 \times 7.6707 = 8.4378 \text{ m}^3/\text{kg}$

Interpolate at 60°C between saturated ( $P = 19.94 \text{ kPa}$ ) and superheated vapor  $P = 10 \text{ kPa}$  in Tables B.1.1 and B.1.3

$$P \cong 19.941 + (10 - 19.941) \frac{8.4378 - 7.6707}{15.3345 - 7.6707} = \mathbf{18.9 \text{ kPa}}$$

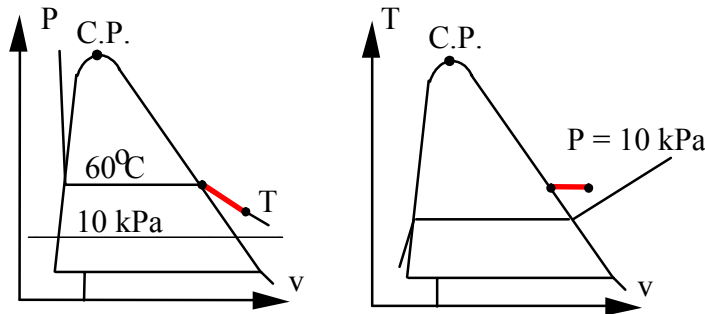

Comment:  $T, v \Rightarrow P = 18 \text{ kPa}$  (software)  $v$  is not linear in  $P$ , more like  $1/P$ , so the linear interpolation in  $P$  is not very accurate.

## 3.56

Ammonia at  $20^{\circ}\text{C}$  with a quality of 50% and total mass 2 kg is in a rigid tank with an outlet valve at the bottom. How much liquid (mass) can you take out through the valve assuming the temperature stays constant?

Solution:

The bottom has liquid until the state inside becomes saturated vapor.

$$V = m_1 v_1 = 2 \times 0.5 (0.001638 + 0.14922) = 0.15086 \text{ m}^3$$

$$m_2 = V/v_2 = 0.15086 \text{ m}^3 / 0.14922 \text{ m}^3/\text{kg} = 1.0198 \text{ kg}$$

$$m = m_1 - m_2 = 2 - 1.0198 = \mathbf{0.989 \text{ kg}}$$

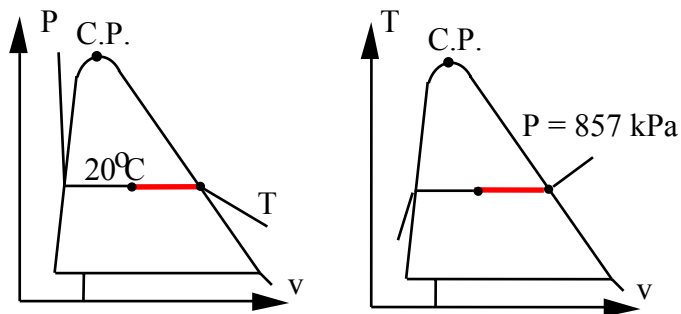

## 3.57

A sealed rigid vessel of  $2 \text{ m}^3$  contains a saturated mixture of liquid and vapor R-134a at  $10^\circ\text{C}$ . If it is heated to  $50^\circ\text{C}$ , the liquid phase disappears. Find the pressure at  $50^\circ\text{C}$  and the initial mass of the liquid.

Solution:

Process: constant volume and constant mass.

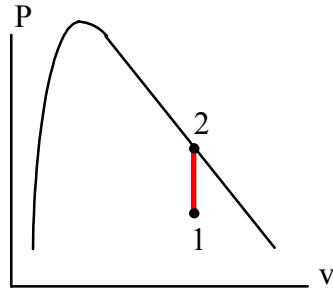

State 2 is saturated vapor, from table B.5.1

$$P_2 = P_{\text{sat}}(50^\circ\text{C}) = \mathbf{1.318 \text{ MPa}}$$

State 1: same specific volume as state 2

$$v_1 = v_2 = 0.015124 \text{ m}^3/\text{kg}$$

$$v_1 = 0.000794 + x_1 \times 0.048658$$

$$\Rightarrow x_1 = 0.2945$$

$$m = V/v_1 = 2/0.015124 = 132.24 \text{ kg}; \quad m_{\text{liq}} = (1 - x_1)m = \mathbf{93.295 \text{ kg}}$$

**3.58**

A storage tank holds methane at 120 K, with a quality of 25 %, and it warms up by 5°C per hour due to a failure in the refrigeration system. How long time will it take before the methane becomes single phase and what is the pressure then?

Solution: Use Table B.7.1

Assume rigid tank  $v = \text{constant} = v_1$

$$v_1 = 0.002439 + 0.25 \times 0.30367 = 0.078366 \text{ m}^3/\text{kg}$$

We then also see that  $v_1 > v_c = 0.00615 \text{ m}^3/\text{kg}$

All single phase when  $v = v_g \Rightarrow T \cong 145 \text{ K}$

$$\Delta t = \frac{\Delta T}{(5^\circ\text{C}/\text{h})} \cong \frac{145 - 120}{5} = \mathbf{5 \text{ hours}} \quad P = P_{\text{sat}} = \mathbf{824 \text{ kPa}}$$

## 3.59

Ammonia at 10°C and mass 0.1 kg is in a piston cylinder with an initial volume of 1 m<sup>3</sup>. The piston initially resting on the stops has a mass such that a pressure of 900 kPa will float it. Now the ammonia is slowly heated to 50°C. Find the final pressure and volume.

Solution:

C.V. Ammonia, constant mass.

Process:  $V = \text{constant}$  unless  $P = P_{\text{float}}$

$$\text{State 1: } T = 10^\circ\text{C}, \quad v_1 = \frac{V}{m} = \frac{1}{10} = 0.1 \text{ m}^3/\text{kg}$$

From Table B.2.1  $v_f < v < v_g$

$$x_1 = \frac{v - v_f}{v_{fg}} = \frac{0.1 - 0.0016}{0.20381} = 0.4828$$

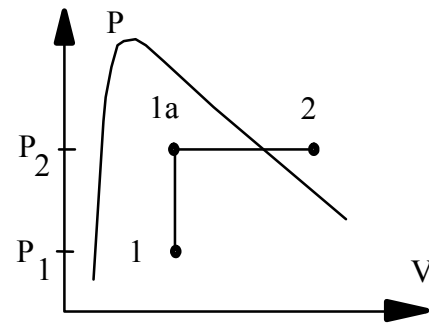

State 1a:  $P = 900 \text{ kPa}$ ,  $v = v_1 = 0.1 \text{ m}^3/\text{kg} < v_g$  at 900 kPa

This state is two-phase  $T_{1a} = 21.52^\circ\text{C}$

Since  $T_2 > T_{1a}$  then  $v_2 > v_{1a}$

State 2: 50°C and on line(s) means

$P_2 = 900 \text{ kPa}$  which is superheated vapor.

Table B.2.2 :  $v_2 = 0.16263 \text{ m}^3/\text{kg}$

$V_2 = mv_2 = 1.6263 \text{ m}^3$

**3.60**

A 400-m<sup>3</sup> storage tank is being constructed to hold LNG, liquified natural gas, which may be assumed to be essentially pure methane. If the tank is to contain 90% liquid and 10% vapor, by volume, at 100 kPa, what mass of LNG (kg) will the tank hold? What is the quality in the tank?

Solution:

CH<sub>4</sub> is in the section B tables.

From Table B.7.1:  $v_f \cong 0.002366 \text{ m}^3/\text{kg}$ , (interpolated)

From Table B.7.2:  $v_g \cong 0.55665 \text{ m}^3/\text{kg}$  (first entry 100 kPa)

$$m_{\text{liq}} = \frac{V_{\text{liq}}}{v_f} = \frac{0.9 \times 400}{0.002366} = 152\,155.5 \text{ kg}; \quad m_{\text{vap}} = \frac{V_{\text{vap}}}{v_g} = \frac{0.1 \times 400}{0.55665} = 71.86 \text{ kg}$$

$$m_{\text{tot}} = 152\,227 \text{ kg}, \quad x = m_{\text{vap}} / m_{\text{tot}} = 4.72 \times 10^{-4}$$



## 3.61

A boiler feed pump delivers  $0.05 \text{ m}^3/\text{s}$  of water at  $240^\circ\text{C}$ ,  $20 \text{ MPa}$ . What is the mass flowrate ( $\text{kg/s}$ )? What would be the percent error if the properties of saturated liquid at  $240^\circ\text{C}$  were used in the calculation? What if the properties of saturated liquid at  $20 \text{ MPa}$  were used?

Solution:

State 1: (T, P) compressed liquid seen in B.1.4:  $v = 0.001205 \text{ m}^3/\text{kg}$

$$\dot{m} = \dot{V}/v = 0.05/0.001205 = \mathbf{41.5 \text{ kg/s}}$$

$$v_{f(240^\circ\text{C})} = 0.001229 \text{ m}^3/\text{kg} \Rightarrow \dot{m} = 40.68 \text{ kg/s} \quad \mathbf{\text{error } 2\%}$$

$$v_{f(20 \text{ MPa})} = 0.002036 \text{ m}^3/\text{kg} \Rightarrow \dot{m} = 24.56 \text{ kg/s} \quad \mathbf{\text{error } 41\%}$$

$$v_{f(20 \text{ MPa})} = 0.002036 \text{ m}^3/\text{kg} \Rightarrow \dot{m} = 24.56 \text{ kg/s} \quad \mathbf{\text{error } 41\%}$$

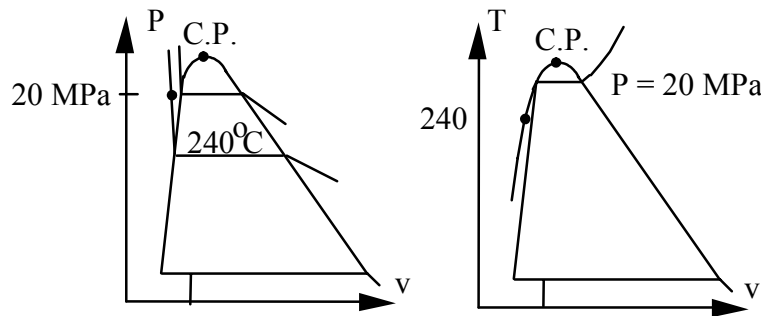

The constant T line is nearly vertical for the liquid phase in the P-v diagram. The state is at so high P, T that the saturated liquid line is not extremely steep.

## 3.62

A piston/cylinder arrangement is loaded with a linear spring and the outside atmosphere. It contains water at 5 MPa, 400°C with the volume being 0.1 m<sup>3</sup>. If the piston is at the bottom, the spring exerts a force such that  $P_{\text{lift}} = 200$  kPa. The system now cools until the pressure reaches 1200 kPa. Find the mass of water, the final state ( $T_2, v_2$ ) and plot the  $P$ - $v$  diagram for the process.

Solution:

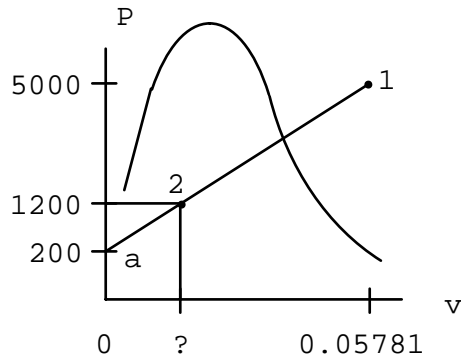

$$1: \text{Table B.1.3} \Rightarrow v_1 = 0.05781 \text{ m}^3/\text{kg}$$

$$m = V/v_1 = 0.1/0.05781 = 1.73 \text{ kg}$$

$$\text{Straight line: } P = P_a + C \times v$$

$$v_2 = v_1 \frac{P_2 - P_a}{P_1 - P_a} = \mathbf{0.01204 \text{ m}^3/\text{kg}}$$

$$v_2 < v_g(1200 \text{ kPa}) \text{ so two-phase } T_2 = \mathbf{188^\circ\text{C}}$$

$$\Rightarrow x_2 = (v_2 - 0.001139)/0.1622 = 0.0672$$

## 3.63

A pressure cooker (closed tank) contains water at 100°C with the liquid volume being 1/10 of the vapor volume. It is heated until the pressure reaches 2.0 MPa. Find the final temperature. Has the final state more or less vapor than the initial state?

Solution:

$$\text{State 1: } V_f = m_f v_f = V_g/10 = m_g v_g/10 ;$$

$$\text{Table B.1.1: } v_f = 0.001044 \text{ m}^3/\text{kg}, v_g = 1.6729 \text{ m}^3/\text{kg}$$

$$x_1 = \frac{m_g}{m_g + m_f} = \frac{10 m_f v_f / v_g}{m_f + 10 m_f v_f / v_g} = \frac{10 v_f}{10 v_f + v_g} = \frac{0.01044}{0.01044 + 1.6729} = 0.0062$$

$$v_1 = 0.001044 + 0.0062 \times 1.67185 = 0.01141 \text{ m}^3/\text{kg}$$

$$\text{State 2: } v_2 = v_1 = 0.01141 \text{ m}^3/\text{kg} < v_g(2\text{MPa}) \text{ from B.1.2 so two-phase}$$

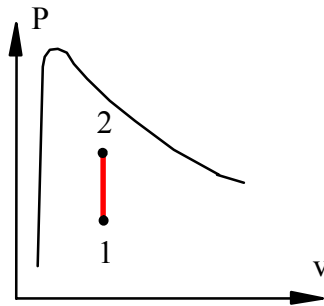

$$\text{At state 2: } v_2 = v_f + x_2 v_{fg}$$

$$0.01141 = 0.001177 + x_2 \times 0.09845$$

$$\Rightarrow x_2 = 0.104$$

**More vapor at final state**

$$T_2 = T_{\text{sat}}(2\text{MPa}) = 212.4^\circ\text{C}$$

**3.64**

A pressure cooker has the lid screwed on tight. A small opening with  $A = 5 \text{ mm}^2$  is covered with a petcock that can be lifted to let steam escape. How much mass should the petcock have to allow boiling at  $120^\circ\text{C}$  with an outside atmosphere at  $101.3 \text{ kPa}$ ?

Table B.1.1.:  $P_{\text{sat}} = 198.5 \text{ kPa}$

$$\begin{aligned} F &= mg = \Delta P \times A \\ m &= \Delta P \times A / g \\ &= \frac{(198.5 - 101.3) \times 1000 \times 5 \times 10^{-6}}{9.807} \\ &= 0.0496 \text{ kg} = \mathbf{50 \text{ g}} \end{aligned}$$

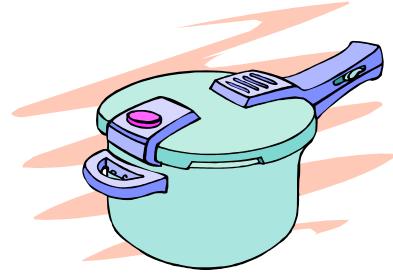

## Ideal Gas Law

Excerpts from this work may be reproduced by instructors for distribution on a not-for-profit basis for testing or instructional purposes only to students enrolled in courses for which this textbook has been adopted. *Any other reproduction or translation of this work beyond that permitted by Sections 107 or 108 of the 1976 United States Copyright Act without the permission of the copyright owner is unlawful.*

## 3.65

What is the relative (%) change in  $P$  if we double the absolute temperature of an ideal gas keeping mass and volume constant? What will it be if we double  $V$  having  $m, T$  constant.

Ideal gas law:  $PV = mRT$

State 2:  $P_2V = mRT_2 = mR2T_1 = 2P_1V \quad \Rightarrow \quad P_2 = 2P_1$   
 Relative change  $= \Delta P/P_1 = P_2/P_1 - 1 = 1 = \mathbf{100\%}$

State 3:  $P_3V_3 = mRT_1 = P_1V_1 \quad \Rightarrow \quad P_3 = P_1V_1/V_3 = P_1/2$   
 Relative change  $= \Delta P/P_1 = P_3/P_1 - 1 = -0.5 = \mathbf{-50\%}$

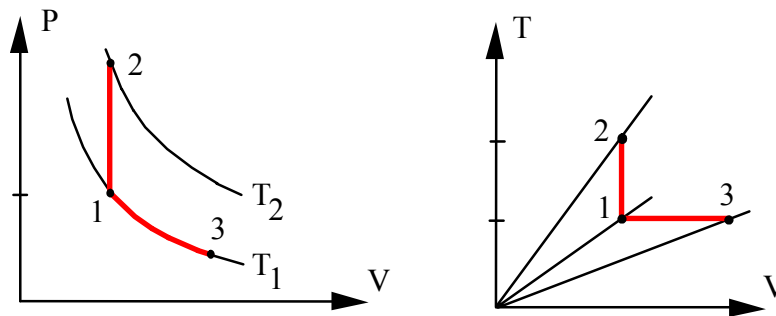

**3.66**

A 1-m<sup>3</sup> tank is filled with a gas at room temperature 20°C and pressure 100 kPa. How much mass is there if the gas is a) air, b) neon or c) propane ?

Solution:

Use Table A.2 to compare T and P to the critical T and P with

$$T = 20^\circ\text{C} = 293.15 \text{ K}; \quad P = 100 \text{ kPa} \ll P_c \quad \text{for all}$$

Air:  $T \gg T_{C,N_2}$ ;  $T_{C,O_2} = 154.6 \text{ K}$       so ideal gas;  $R = 0.287 \text{ kJ/kg K}$

Neon:  $T \gg T_c = 44.4 \text{ K}$       so ideal gas;  $R = 0.41195 \text{ kJ/kg K}$

Propane:  $T < T_c = 370 \text{ K}$ , but  $P \ll P_c = 4.25 \text{ MPa}$

so gas  $R = 0.18855 \text{ kJ/kg K}$

All states are ideal gas states so the ideal gas law applies

$$PV = mRT$$

$$\text{a) } m = \frac{PV}{RT} = \frac{100 \times 1}{0.287 \times 293.15} = \mathbf{1.189 \text{ kg}}$$

$$\text{b) } m = \frac{100 \times 1}{0.41195 \times 293.15} = \mathbf{0.828 \text{ kg}}$$

$$\text{c) } m = \frac{100 \times 1}{0.18855 \times 293.15} = \mathbf{1.809 \text{ kg}}$$

**3.67**

Calculate the ideal gas constant for argon and hydrogen based on table A.2 and verify the value with Table A.5

argon:  $R = \bar{R} / M = 8.3145 / 39.948 = 0.2081$  same as Table A.5

hydrogen:  $R = \bar{R} / M = 8.3145 / 2.016 = 4.124256$  same as Table A.5



**3.68**

A pneumatic cylinder (a piston cylinder with air) must close a door with a force of 500 N. The cylinder cross-sectional area is 5 cm<sup>2</sup> and its volume is 50 cm<sup>3</sup>. What is the air pressure and its mass?

$$F = PA - P_oA \Rightarrow$$

$$P = P_o + F/A = 100 \text{ kPa} + \frac{500 \text{ N}}{0.0005 \text{ m}^2 \times 1000 \text{ N/kN}} = \mathbf{1100 \text{ kPa}}$$

$$m = \frac{P_1 V_1}{RT_1} = \frac{1100 \text{ kPa} \times 0.00005 \text{ m}^3}{0.287 \text{ kJ/kgK} \times 298 \text{ K}} = \mathbf{0.00064 \text{ kg} = 0.64 \text{ g}}$$

Comment: Dependent upon your understanding of the problem you could also have neglected the atmospheric pressure to get 1000 kPa and 0.58 g for answers.

## 3.69

Is it reasonable to assume that at the given states the substance behaves as an ideal gas?

Solution:

- |                    |                  |                                                          |
|--------------------|------------------|----------------------------------------------------------|
| a) Oxygen, $O_2$   | at 30°C, 3 MPa   | <b>Ideal Gas</b> ( $T \gg T_c = 155 \text{ K}$ from A.2) |
| b) Methane, $CH_4$ | at 30°C, 3 MPa   | <b>Ideal Gas</b> ( $T \gg T_c = 190 \text{ K}$ from A.2) |
| c) Water, $H_2O$   | at 30°C, 3 MPa   | <b>NO</b> compressed liquid $P > P_{\text{sat}}$ (B.1.1) |
| d) R-134a          | at 30°C, 3 MPa   | <b>NO</b> compressed liquid $P > P_{\text{sat}}$ (B.5.1) |
| e) R-134a          | at 30°C, 100 kPa | <b>Ideal Gas</b> $P$ is low $< P_{\text{sat}}$ (B.5.1)   |

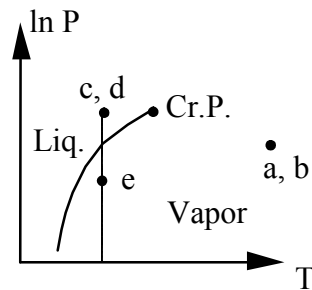

## 3.70

Helium in a steel tank is at 250 kPa, 300 K with a volume of  $0.1 \text{ m}^3$ . It is used to fill a balloon. When the pressure drops to 150 kPa, the flow of helium stops by itself. If all the helium still is at 300 K, how big a balloon did I get?

Solution:

State 1:  $m = V/v$  assume ideal gas so

$$m = \frac{P_1 V_1}{RT_1} = \frac{250 \times 0.1}{2.0771 \times 300} = 0.0401 \text{ kg}$$

State 2: Same mass so then ( $T_2 = T_1$ )

$$\begin{aligned} V_2 &= \frac{mRT_2}{P_2} = \frac{P_1 V_1 RT_2}{RT_1 P_2} = V_1 \frac{P_1}{P_2} \\ &= 0.1 \frac{250}{150} = 0.16667 \text{ m}^3 \end{aligned}$$

The balloon volume is

$$V_{\text{balloon}} = V_2 - V_1 = 0.16667 - 0.1 = \mathbf{0.06667 \text{ m}^3}$$

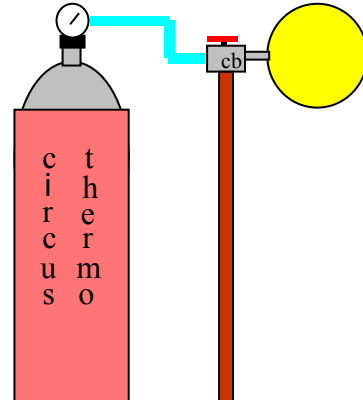

**3.71**

A hollow metal sphere of 150-mm inside diameter is weighed on a precision beam balance when evacuated and again after being filled to 875 kPa with an unknown gas. The difference in mass is 0.0025 kg, and the temperature is 25°C. What is the gas, assuming it is a pure substance listed in Table A.5 ?

Solution:

Assume an ideal gas with total volume:  $V = \frac{\pi}{6}(0.15)^3 = 0.001767 \text{ m}^3$

$$M = \frac{m\bar{R}T}{PV} = \frac{0.0025 \times 8.3145 \times 298.2}{875 \times 0.001767} = \mathbf{4.009} \approx M_{\text{He}}$$

=> **Helium Gas**

## 3.72

A spherical helium balloon of 10 m in diameter is at ambient T and P, 15°C and 100 kPa. How much helium does it contain? It can lift a total mass that equals the mass of displaced atmospheric air. How much mass of the balloon fabric and cage can then be lifted?

We need to find the masses and the balloon volume

$$V = \frac{\pi}{6} D^3 = \frac{\pi}{6} 10^3 = 523.6 \text{ m}^3$$

$$m_{\text{He}} = \rho V = \frac{V}{v} = \frac{PV}{RT} = \frac{100 \text{ kPa} \times 523.6 \text{ m}^3}{2.0771 \text{ kJ/kgK} \times 288 \text{ K}} = \mathbf{87.5 \text{ kg}}$$

$$m_{\text{air}} = \frac{PV}{RT} = \frac{100 \text{ kPa} \times 523.6 \text{ m}^3}{0.287 \text{ kJ/kgK} \times 288 \text{ K}} = 633 \text{ kg}$$

$$m_{\text{lift}} = m_{\text{air}} - m_{\text{He}} = 633 - 87.5 = \mathbf{545.5 \text{ kg}}$$



## 3.73

A glass is cleaned in 45°C hot water and placed on the table bottom up. The room air at 20°C that was trapped in the glass gets heated up to 40°C and some of it leaks out so the net resulting pressure inside is 2 kPa above ambient pressure of 101 kPa. Now the glass and the air inside cools down to room temperature. What is the pressure inside the glass?

Solution:

1 air: 40°C, 103 kPa

2 air: 20°C, ?

Constant Volume:  $V_1 = V_2$ ,

Constant Mass  $m_1 = m_2$

Ideal Gas  $P_1V_1 = m_1RT_1$  and  $P_2V_2 = m_1RT_2$

Take Ratio

$$P_2 = P_1 \frac{T_1}{T_2} = 103 \times \frac{20 + 273}{40 + 273} = \mathbf{96.4 \text{ kPa}}$$

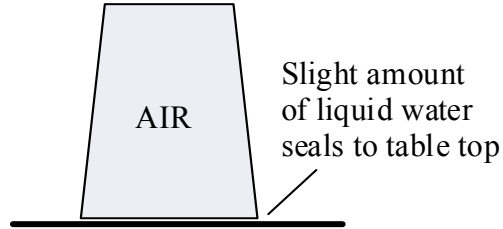

This is a vacuum relative to atm pressure so the glass is pressed against table.

## 3.74

Air in an internal combustion engine has 227°C, 1000 kPa with a volume of 0.1 m<sup>3</sup>. Now combustion heats it to 1500 K in a constant volume process. What is the mass of air and how high does the pressure become?

The mass comes from knowledge of state 1 and ideal gas law

$$m = \frac{P_1 V_1}{RT_1} = \frac{1000 \text{ kPa} \times 0.1 \text{ m}^3}{0.287 \text{ kJ/kgK} \times (227 + 273) \text{ K}} = \mathbf{0.697 \text{ kg}}$$

The final pressure is found from the ideal gas law written for state 1 and state 2 and then eliminate the mass, gas constant and volume ( $V_2 = V_1$ ) between the equations

$$P_1 V_1 = m R T_1 \quad \text{and} \quad P_2 V_2 = m R T_2$$

$$P_2 = P_1 \times T_2/T_1 = 1000 \times \frac{1500}{500} = \mathbf{3000 \text{ kPa}}$$

**3.75**

Air in an automobile tire is initially at  $-10^{\circ}\text{C}$  and 190 kPa. After the automobile is driven awhile, the temperature gets up to  $10^{\circ}\text{C}$ . Find the new pressure. You must make one assumption on your own.

Solution:

Assume constant volume and that air is an ideal gas

$$\begin{aligned} P_2 &= P_1 \times T_2/T_1 \\ &= 190 \times \frac{283.15}{263.15} = \mathbf{204.4 \text{ kPa}} \end{aligned}$$

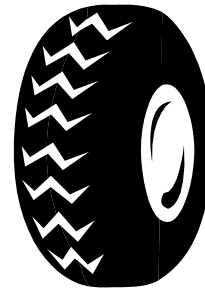



**3.76**

A rigid tank of 1 m<sup>3</sup> contains nitrogen gas at 600 kPa, 400 K. By mistake someone lets 0.5 kg flow out. If the final temperature is 375 K what is then the final pressure?

Solution:

$$m = \frac{PV}{RT} = \frac{600 \times 1}{0.2968 \times 400} = 5.054 \text{ kg}$$

$$m_2 = m - 0.5 = 4.554 \text{ kg}$$

$$P_2 = \frac{m_2 RT_2}{V} = \frac{4.554 \times 0.2968 \times 375}{1} = \mathbf{506.9 \text{ kPa}}$$

## 3.77

Assume we have 3 states of saturated vapor R-134a at +40 °C, 0 °C and -40 °C. Calculate the specific volume at the set of temperatures and corresponding saturated pressure assuming ideal gas behavior. Find the percent relative error =  $100(v - v_g)/v_g$  with  $v_g$  from the saturated R-134a table.

Solution:

R-134a. Table values from Table B.5.1  $P_{\text{sat}}, v_g(T)$

Ideal gas constant from Table A.5:  $R_{\text{R-134a}} = 0.08149 \text{ kJ/kg K}$

T	$P_{\text{sat}}, \text{kPa}$	$v_g$	$v_{\text{ID.G.}} = RT / P_{\text{sat}}$	error %
-40 °C	51.8	0.35696	0.36678	2.75
0 °C	294	0.06919	0.07571	9.4
40 °C	1017	0.02002	0.02509	25.3

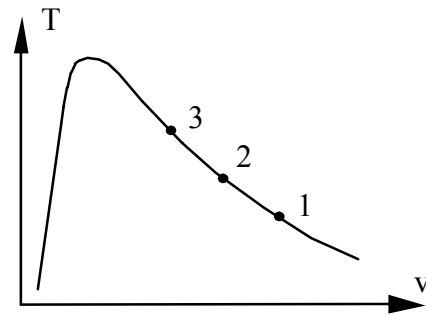
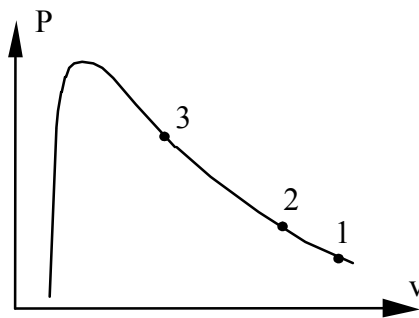

## 3.78

Do Problem 3.77, but for the substance R-410a.

Solution:

R-410a. Table values from Table B.4.1  $P_{\text{sat}}, v_g(T)$

Ideal gas constant from Table A.5:  $R_{\text{R-410a}} = 0.1146 \text{ kJ/kg K}$

T	$P_{\text{sat}}, \text{kPa}$	$v_g$	$v_{\text{ID.G.}} = RT / P_{\text{sat}}$	error %
-40 °C	175.0	0.14291	0.1527	6.8
0 °C	798.7	0.03267	0.03919	20
40 °C	2420.7	0.00967	0.01483	53.3

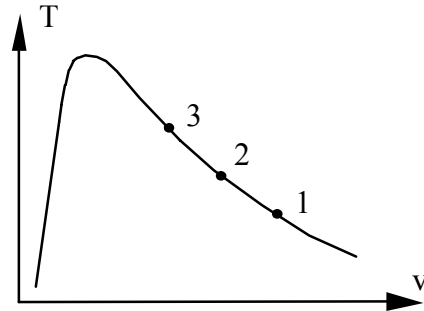
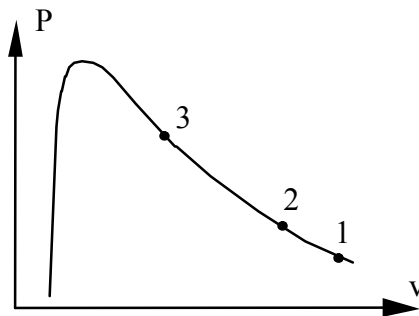

## 3.79

Do Problem 3.77, but for the substance ammonia.

Solution:

NH<sub>3</sub>. Table values from Table B.2.1  $P_{\text{sat}}, v_g(T)$

Ideal gas constant from Table A.5:  $R_{\text{ammonia}} = 0.4882 \text{ kJ/kg K}$

T	$P_{\text{sat}}$ , kPa	$v_g$	$v_{\text{ID.G.}} = RT / P_{\text{sat}}$	error %
-40 °C	71.7	1.5526	1.5875	2.25
0 °C	429.6	0.28929	0.3104	7.3
40 °C	1555	0.08313	0.09832	18.3

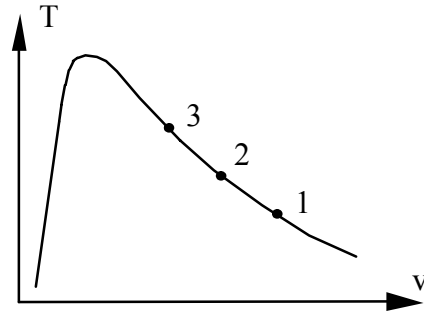
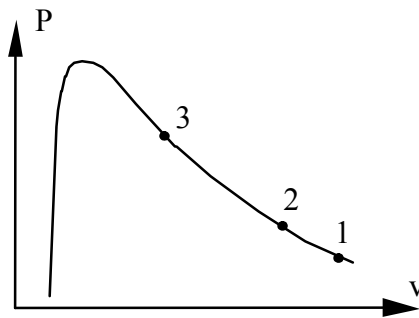

**3.80**

A 1 m<sup>3</sup> rigid tank has propane at 100 kPa, 300 K and connected by a valve to another tank of 0.5 m<sup>3</sup> with propane at 250 kPa, 400 K. The valve is opened and the two tanks come to a uniform state at 325 K. What is the final pressure?

Solution:

Propane is an ideal gas ( $P \ll P_c$ ) with  $R = 0.1886$  kJ/kgK from Tbl. A.5

$$m_A = \frac{P_A V_A}{RT_A} = \frac{100 \times 1}{0.1886 \times 300} = 1.7674 \text{ kg}$$

$$m_B = \frac{P_B V_B}{RT_B} = \frac{250 \times 0.5}{0.1886 \times 400} = 1.6564 \text{ kg}$$

$$V_2 = V_A + V_B = 1.5 \text{ m}^3$$

$$m_2 = m_A + m_B = 3.4243 \text{ kg}$$

$$P_2 = \frac{m_2 R T_2}{V_2} = \frac{3.4243 \times 0.1886 \times 325}{1.5} = \mathbf{139.9 \text{ kPa}}$$

**3.81**

A vacuum pump is used to evacuate a chamber where some specimens are dried at 50°C. The pump rate of volume displacement is 0.5 m<sup>3</sup>/s with an inlet pressure of 0.1 kPa and temperature 50°C. How much water vapor has been removed over a 30-min period?

Solution:

Use ideal gas since  $P \ll$  lowest  $P$  in steam tables.

From table A.5 we get  $R = 0.46152$  kJ/kg K

$m = \dot{m} \Delta t$  with mass flow rate as:  $\dot{m} = \dot{V}/v = P\dot{V}/RT$  (ideal gas)

$$\Rightarrow m = P\dot{V}\Delta t/RT = \frac{0.1 \times 0.5 \times 30 \times 60}{(0.46152 \times 323.15)} = \mathbf{0.603 \text{ kg}}$$

**3.82**

A 1-m<sup>3</sup> rigid tank with air at 1 MPa, 400 K is connected to an air line as shown in Fig. P3.82. The valve is opened and air flows into the tank until the pressure reaches 5 MPa, at which point the valve is closed and the temperature inside is 450K.

- What is the mass of air in the tank before and after the process?
- The tank eventually cools to room temperature, 300 K. What is the pressure inside the tank then?

Solution:

P, T known at both states and assume the air behaves as an ideal gas.

$$m_{\text{air1}} = \frac{P_1 V}{RT_1} = \frac{1000 \times 1}{0.287 \times 400} = \mathbf{8.711 \text{ kg}}$$

$$m_{\text{air2}} = \frac{P_2 V}{RT_2} = \frac{5000 \times 1}{0.287 \times 450} = \mathbf{38.715 \text{ kg}}$$

Process 2 → 3 is constant V, constant mass cooling to T<sub>3</sub>

$$P_3 = P_2 \times (T_3/T_2) = 5000 \times (300/450) = \mathbf{3.33 \text{ MPa}}$$

**3.83**

A cylindrical gas tank 1 m long, inside diameter of 20 cm, is evacuated and then filled with carbon dioxide gas at 20°C. To what pressure should it be charged if there should be 1.2 kg of carbon dioxide?

Solution:

Assume CO<sub>2</sub> is an ideal gas, table A.5:  $R = 0.1889 \text{ kJ/kg K}$

$$V_{\text{cyl}} = A \times L = \frac{\pi}{4}(0.2)^2 \times 1 = 0.031416 \text{ m}^3$$

$$P V = mRT \quad \Rightarrow \quad P = \frac{mRT}{V}$$

$$\Rightarrow P = \frac{1.2 \text{ kg} \times 0.1889 \text{ kJ/kg K} \times (273.15 + 20) \text{ K}}{0.031416 \text{ m}^3} = \mathbf{2115 \text{ kPa}}$$



## 3.84

Ammonia in a piston/cylinder arrangement is at 700 kPa, 80°C. It is now cooled at constant pressure to saturated vapor (state 2) at which point the piston is locked with a pin. The cooling continues to  $-10^\circ\text{C}$  (state 3). Show the processes 1 to 2 and 2 to 3 on both a  $P$ - $v$  and  $T$ - $v$  diagram.

Solution:

State 1:  $T, P$  from table B.2.2 this is superheated vapor.

State 2:  $T, x$  from table B.2.1

State 3:  $T, v$  two-phase

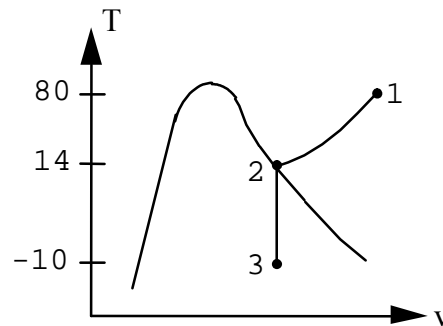
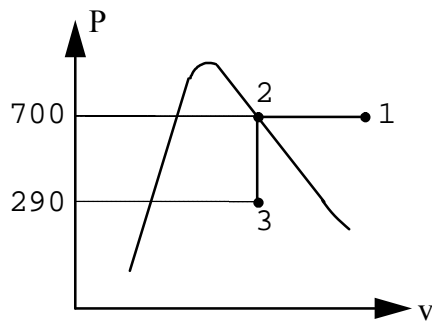

## Compressibility Factor

Excerpts from this work may be reproduced by instructors for distribution on a not-for-profit basis for testing or instructional purposes only to students enrolled in courses for which this textbook has been adopted. *Any other reproduction or translation of this work beyond that permitted by Sections 107 or 108 of the 1976 United States Copyright Act without the permission of the copyright owner is unlawful.*

## 3.85

How close to ideal gas behavior (find  $Z$ ) is ammonia at saturated vapor, 100 kPa?  
How about saturated vapor at 2000 kPa?

Table B.2.2:  $v_1 = 1.1381 \text{ m}^3/\text{kg}$ ,  $T_1 = -33.6^\circ\text{C}$ ,  $P_1 = 100 \text{ kPa}$

$v_2 = 0.06444 \text{ m}^3/\text{kg}$ ,  $T_2 = 49.37^\circ\text{C}$ ,  $P_2 = 2000 \text{ kPa}$

Table A.5:  $R = 0.4882 \text{ kJ/kg K}$

Extended gas law:  $Pv = ZRT$  so we can calculate  $Z$  from this

$$Z_1 = \frac{P_1 v_1}{RT_1} = \frac{100 \times 1.1381}{0.4882 \times (273.15 - 33.6)} = 0.973$$

$$Z_2 = \frac{P_2 v_2}{RT_2} = \frac{2000 \times 0.06444}{0.4882 \times (273.15 + 49.37)} = 0.8185$$

So state 1 is close to ideal gas and state 2 is not so close.

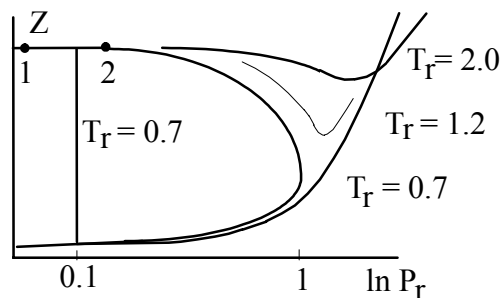

**3.86**

Carbon dioxide at 60°C is pumped at a very high pressure 10 MPa into an oil well to reduce the oil viscosity for better oil flow. What is its compressibility?

Table B.3.2:  $v = 0.00345 \text{ m}^3/\text{kg}$

$$Z = Pv/RT = \frac{10\,000 \text{ kPa} \times 0.00345 \text{ m}^3/\text{kg}}{0.1889 \text{ kJ/kg-K} \times 333 \text{ K}} = \mathbf{0.55}$$

## 3.87

Find the compressibility for carbon dioxide at 60°C and 10 MPa using Fig. D.1

Solution:

Table A.2      CO<sub>2</sub>:  $T_c = 304.1 \text{ K}$        $P_c = 7.38 \text{ MPa}$

$$T_r = T/T_c = 333/304.1 = 1.095$$

$$P_r = P/P_c = 10/7.38 = 1.355$$

From Figure D.1:       $Z \approx 0.45$

Compare with table B.3.2:       $v = 0.00345 \text{ m}^3/\text{kg}$

$$Z = Pv/RT = \frac{10\,000 \text{ kPa} \times 0.00345 \text{ m}^3/\text{kg}}{0.1889 \text{ kJ/kg-K} \times 333 \text{ K}} = 0.55$$

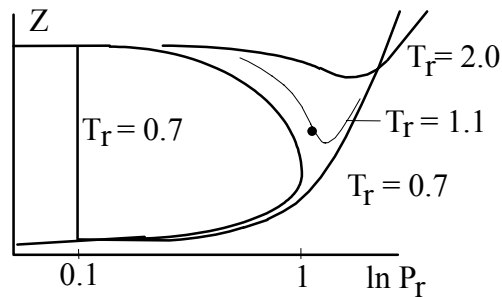

**3.88**

What is the percent error in specific volume if the ideal gas model is used to represent the behavior of superheated ammonia at 40°C, 500 kPa? What if the generalized compressibility chart, Fig. D.1, is used instead?

Solution:

$\text{NH}_3$   $T = 40^\circ\text{C} = 313.15 \text{ K}$ ,  $T_c = 405.5 \text{ K}$ ,  $P_c = 11.35 \text{ MPa}$  from Table A.1

Table B.2.2:  $v = \mathbf{0.2923 \text{ m}^3/\text{kg}}$

Ideal gas:  $v = \frac{RT}{P} = \frac{0.48819 \times 313}{500} = \mathbf{0.3056 \text{ m}^3/\text{kg}} \Rightarrow \mathbf{4.5\% \text{ error}}$

Figure D.1:  $T_r = \frac{313.15}{405.5} = 0.772$ ,  $P_r = \frac{0.5}{11.35} = 0.044 \Rightarrow Z = \mathbf{0.97}$

$v = \frac{ZRT}{P} = \mathbf{0.2964 \text{ m}^3/\text{kg}} \Rightarrow \mathbf{1.4\% \text{ error}}$

**3.89**

A cylinder fitted with a frictionless piston contains butane at 25°C, 500 kPa. Can the butane reasonably be assumed to behave as an ideal gas at this state ?

Solution

Butane 25°C, 500 kPa, Table A.2:  $T_c = 425 \text{ K}$ ;  $P_c = 3.8 \text{ MPa}$

$$T_r = \frac{25 + 273}{425} = 0.701; \quad P_r = \frac{0.5}{3.8} = 0.13$$

Look at generalized chart in Figure D.1

$$\text{Actual } P_r > P_{r,\text{sat}} = 0.1 \quad \Rightarrow \quad \text{liquid!! not a gas}$$

The pressure should be less than 380 kPa to have a gas at that T.

**3.90**

Estimate the saturation pressure of chlorine at 300 K.

Solution:

We do not have a table in the B section for Chlorine so we must use the generalized chart.

Table A.2:  $P_c = 7.98 \text{ MPa}$ ,  $T_c = 416.9 \text{ K}$

$$T_r = T/T_c = 300 / 416.9 = 0.7196$$

Figure D.1:  $P_{r \text{ sat}} = 0.13$  (same estimation from Table D.4)

$$P = P_c P_{r \text{ sat}} = 7.98 \times 0.13 = \mathbf{1.04 \text{ MPa}}$$

If you use the CATT3 program then you will find  $P_{r \text{ sat}} = 0.122$  and  $P = 973 \text{ kPa}$



## 3.91

A bottle with a volume of  $0.1 \text{ m}^3$  contains butane with a quality of 75% and a temperature of 300 K. Estimate the total butane mass in the bottle using the generalized compressibility chart.

Solution:

We need to find the property  $v$  the mass is:  $m = V/v$

so find  $v$  given  $T_1$  and  $x$  as:  $v = v_f + x v_{fg}$

Table A.2: Butane  $T_c = 425.2 \text{ K}$   $P_c = 3.8 \text{ MPa} = 3800 \text{ kPa}$

$T_r = 300/425.2 = 0.705 \Rightarrow$

From Fig. D.1 or table D.4:  $Z_f \approx 0.02$ ;  $Z_g \approx 0.9$ ;  $P_{r \text{ sat}} = 0.1$

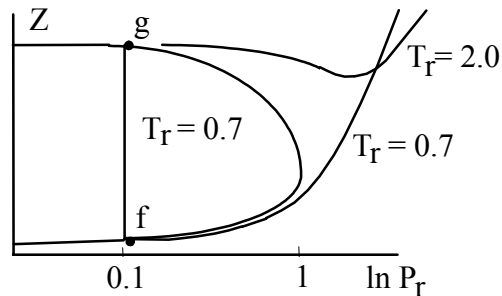

$$P = P_{\text{sat}} = P_{r \text{ sat}} \times P_c = 0.1 \times 3.80 \times 1000 = 380 \text{ kPa}$$

$$v_f = Z_f RT/P = 0.02 \times 0.14304 \times 300/380 = 0.00226 \text{ m}^3/\text{kg}$$

$$v_g = Z_g RT/P = 0.9 \times 0.14304 \times 300/380 = 0.1016 \text{ m}^3/\text{kg}$$

$$v = 0.00226 + 0.75 \times (0.1016 - 0.00226) = 0.076765 \text{ m}^3/\text{kg}$$

$$m = \frac{V}{v} = \frac{0.1}{0.076765} = \mathbf{1.303 \text{ kg}}$$

## 3.92

Find the volume of 2 kg of ethylene at 270 K, 2500 kPa using  $Z$  from Fig. D.1

Ethylene Table A.2:  $T_c = 282.4$  K,  $P_c = 5.04$  MPa

Table A.5:  $R = 0.2964$  kJ/kg K

The reduced temperature and pressure are:

$$T_r = \frac{T}{T_c} = \frac{270}{282.4} = 0.956, \quad P_r = \frac{P}{P_c} = \frac{2.5}{5.04} = 0.496$$

Enter the chart with these coordinates and read:  $Z = 0.76$

$$V = \frac{mZRT}{P} = \frac{2 \text{ kg} \times 0.76 \times 0.2964 \text{ kJ/kg-K} \times 270 \text{ K}}{2500 \text{ kPa}} = \mathbf{0.0487 \text{ m}^3}$$

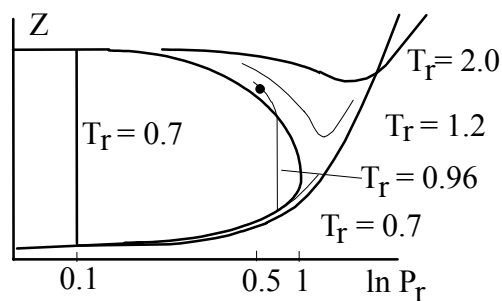

## 3.93

With  $T_r = 0.85$  and a quality of 0.6, find the compressibility factor using Fig. D.1

For the saturated states we will use Table D.4 instead of the figure. There we can see at  $T_r = 0.85$

$$Z_f = 0.062, \quad Z_g = 0.747$$

$$Z = (1 - x) Z_f + x Z_g = (1 - 0.6) 0.062 + 0.6 \times 0.747 = \mathbf{0.473}$$

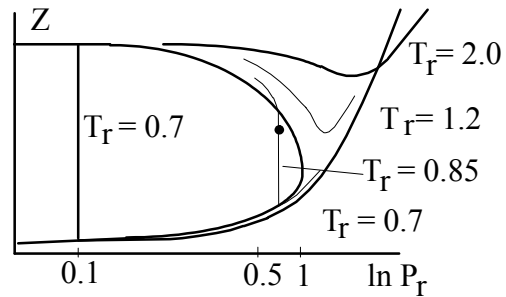

**3.94**

Argon is kept in a rigid 5 m<sup>3</sup> tank at -30°C, 3 MPa. Determine the mass using the compressibility factor. What is the error (%) if the ideal gas model is used?

Solution:

No Argon table, so we use generalized chart Fig. D.1

$$T_r = 243.15/150.8 = 1.612, \quad P_r = 3000/4870 = 0.616 \quad \Rightarrow \quad Z \cong 0.96$$

$$m = \frac{PV}{ZRT} = \frac{3000 \times 5}{0.96 \times 0.2081 \times 243.2} = \mathbf{308.75 \text{ kg}}$$

Ideal gas  $Z = 1$

$$m = \frac{PV}{RT} = 296.4 \text{ kg} \quad \mathbf{4\% \text{ error}}$$

## 3.95

Refrigerant R-32 is at  $-10\text{ }^{\circ}\text{C}$  with a quality of 15%. Find the pressure and specific volume.

Solution:

For R-32 there is no section B table printed. We will use compressibility chart.

From Table A.2:  $T_c = 351.3\text{ K}$ ;  $P_c = 5.78\text{ MPa}$ ;

From Table A.5:  $R = 0.1598\text{ kJ/kg K}$

$$T_r = T/T_c = 263/351.3 = 0.749$$

From Table D.4 or Figure D.1,  $Z_f \approx 0.029$ ;  $Z_g \approx 0.86$ ;  $P_{r\text{ sat}} \approx 0.16$

$$P = P_{r\text{ sat}} P_c = 0.16 \times 5780 = \mathbf{925\text{ kPa}}$$

$$\begin{aligned} v &= v_f + x v_{fg} = (Z_f + x \times Z_{fg}) RT/P \\ &= [0.029 + 0.15 \times (0.86 - 0.029)] \times 0.1598\text{ kJ/kg-K} \times 263\text{ K} / 925\text{ kPa} \\ &= \mathbf{0.007\text{ m}^3/\text{kg}} \end{aligned}$$

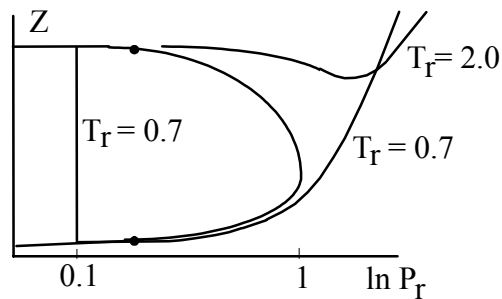

**3.96**

To plan a commercial refrigeration system using R-123 we would like to know how much more volume saturated vapor R-123 occupies per kg at  $-30\text{ }^{\circ}\text{C}$  compared to the saturated liquid state.

Solution:

For R-123 there is no section B table printed. We will use compressibility chart.

From Table A.2  $T_c = 456.9\text{ K}$ ;  $P_c = 3.66\text{ MPa}$ ;  $M = 152.93$

$$T_r = T/T_c = 243/456.9 = 0.53$$

$$R = \bar{R}/M = 8.31451 / 152.93 = 0.0544$$

The value of  $T_r$  is below the range in Fig. D.1 so use the table D.4

Table D.4,  $Z_g = 0.979$   $Z_f = 0.00222$

$$Z_{fg} = 0.979 - 0.0022 = 0.9768; \quad P_r = P_{r\text{ sat}} = 0.0116$$

$$P = P_r \times P_c = 42.5\text{ kPa}$$

$$v_{fg} = Z_{fg} RT/P = 0.9768 \times 0.0544 \times 243 / 42.5 = \mathbf{0.304\text{ m}^3/\text{kg}}$$

**Comment:** If you check with the software the solution is off by a factor of 6. The linear interpolation is poor and so is the approximation for  $P_{r\text{ sat}}$  so the real saturation pressure should be 6.75 kPa. Also the very small value of  $Z_f$  is inaccurate by itself, minute changes in the curve gives large relative variations.

## 3.97

A new refrigerant R-125 is stored as a liquid at  $-20\text{ }^{\circ}\text{C}$  with a small amount of vapor. For a total of 1.5 kg R-125 find the pressure and the volume.

Solution:

As there is no section B table use compressibility chart.

Table A.2: R-125  $T_c = 339.2\text{ K}$   $P_c = 3.62\text{ MPa}$

$$T_r = T / T_c = 253.15 / 339.2 = 0.746$$

We can read from Figure D.1 or a little more accurately interpolate from table D.4 entries:

$$P_{r\text{ sat}} = 0.16 ; Z_g = 0.86 ; Z_f = 0.029$$

$$P = P_{r\text{ sat}} P_c = 0.16 \times 3620\text{ kPa} = \mathbf{579\text{ kPa}}$$

$$\begin{aligned} V_{\text{liq}} &= Z_f m_{\text{liq}} RT/P = 0.029 \times 1.5\text{ kg} \times 0.06927\text{ kJ/kgK} \times 253.15\text{ K} / 579\text{ kPa} \\ &= \mathbf{0.0013\text{ m}^3} \end{aligned}$$

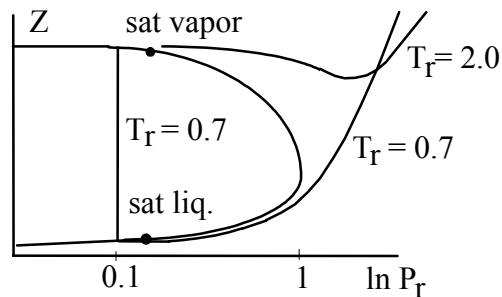

## Equations of State

For these problems see appendix D for the equation of state (EOS) and chapter 14.



**3.98**

Determine the pressure of nitrogen at 160 K,  $v = 0.00291 \text{ m}^3/\text{kg}$  using ideal gas, van der Waal Equation of State and the nitrogen table.

Nitrogen from table A.2:  $T_c = 126.2 \text{ K}$ ,  $P_c = 3390 \text{ kPa}$ ,

$$\text{Ideal gas: } P = \frac{RT}{v} = \frac{0.2968 \times 160}{0.00291} \frac{\text{kJ/kg-K} \times \text{K}}{\text{m}^3/\text{kg}} = \mathbf{16\ 319 \text{ kPa}}$$

For **van der Waal equation of state** from Table D.1 we have

$$b = \frac{1}{8} \frac{RT_c}{P_c} = 0.125 \times \frac{0.2968 \times 126.2}{3390} = 0.001\ 381 \text{ m}^3/\text{kg},$$

$$a = 27 b^2 P_c = 27 \times (0.001\ 381)^2 \times 3390 = 0.174\ 562 \text{ kPa (m}^3/\text{kg)}^2$$

$$\text{The EOS is: } P = \frac{RT}{v - b} - \frac{a}{v^2} = \frac{0.2968 \times 160}{0.00291 - 0.001\ 381} - \frac{0.174\ 562}{0.00291^2} = \mathbf{10\ 444 \text{ kPa}}$$

Table B.6.2:  $P = \mathbf{10\ 000 \text{ kPa}}$ .

## 3.99

Determine the pressure of nitrogen at 160 K,  $v = 0.00291 \text{ m}^3/\text{kg}$  using Redlich-Kwong Equation of State and the nitrogen table.

Nitrogen from table A.2:  $T_c = 126.2 \text{ K}$ ,  $P_c = 3390 \text{ kPa}$ ,  
 $T_r = T/T_c = 160/126.2 = 1.26783$

For **Redlich-Kwong EOS** we have the parameters from Table D.1

$$b = 0.08664 \frac{RT_c}{P_c} = 0.08664 \times \frac{0.2968 \times 126.2}{3390} = 0.0009573 \text{ m}^3/\text{kg},$$

$$a = 0.42748 T_r^{-1/2} \frac{R^2 T_c^2}{P_c} = 0.42748 \times \frac{0.2968^2 \times 126.2^2}{1.2678^{1/2} \times 3390} = 0.157122 \text{ kPa (m}^3/\text{kg)}^2$$

The equation is:

$$\begin{aligned} P &= \frac{RT}{v-b} - \frac{a}{v^2 + bv} \\ &= \frac{0.2968 \times 160}{0.00291 - 0.0009573} - \frac{0.157122}{0.00291^2 + 0.0009573 \times 0.00291} \\ &= \mathbf{10\ 357 \text{ kPa}} \end{aligned}$$

Table B.6.2:  $P = \mathbf{10\ 000 \text{ kPa}}$ .

**3.100**

Determine the pressure of nitrogen at 160 K,  $v = 0.00291 \text{ m}^3/\text{kg}$  using Soave Equation of State and the nitrogen table.

Nitrogen from table A.2:  $T_c = 126.2 \text{ K}$ ,  $P_c = 3390 \text{ kPa}$ ,  
 $T_r = T/T_c = 160/126.2 = 1.26783$

For **Soave EOS** see Appendix D (very close to Redlich-Kwong)

$$P = \frac{RT}{v - b} - \frac{a}{v^2 + bv}$$

where the parameters are from Table D.1 and D.4

$$\omega = 0.039$$

$$f = 0.48 + 1.574\omega - 0.176\omega^2 = 0.54112$$

$$a_0 = 0.42748 [1 + f(1 - T_r^{1/2})]^2 = 0.371184$$

$$b = 0.08664 \frac{RT_c}{P_c} = 0.08664 \times \frac{0.2968 \times 126.2}{3390} = 0.0009573 \text{ m}^3/\text{kg},$$

$$a = 0.371184 \frac{R^2 T_c^2}{P_c} = 0.371184 \times \frac{0.2968^2 \times 126.2^2}{3390} = 0.153616 \text{ kPa (m}^3/\text{kg)}^2$$

$$\begin{aligned} P &= \frac{RT}{v - b} - \frac{a}{v^2 + bv} \\ &= \frac{0.2968 \times 160}{0.00291 - 0.0009573} - \frac{0.153616}{0.00291^2 + 0.0009573 \times 0.00291} \\ &= \mathbf{10\ 669 \text{ kPa}} \end{aligned}$$

Nitrogen Table B.6.2:  $P = \mathbf{10\ 000 \text{ kPa}}$ .

## 3.101

Carbon dioxide at 60°C is pumped at a very high pressure 10 MPa into an oil well to reduce the oil viscosity for better oil flow. We want to find its specific volume from the CO<sub>2</sub> table, ideal gas and van der Waals equation of state by iteration.

Table B.3.2:  $v = 0.00345 \text{ m}^3/\text{kg}$ .

$$\text{Ideal gas: } v = \frac{RT}{P} = \frac{0.1889 \times (60 + 273.15) \text{ kJ/kg-K} \times \text{K}}{10\,000 \text{ kPa}} = 0.006\,293 \text{ m}^3/\text{kg}$$

Carbon dioxide from table A.2:  $T_c = 304.1 \text{ K}$ ,  $P_c = 7380 \text{ kPa}$ ,

For **van der Waal equation of state** from Table D.1 we have

$$b = \frac{1}{8} \frac{RT_c}{P_c} = 0.125 \times \frac{0.1889 \times 304.1}{7380} = 0.000\,972\,98 \text{ m}^3/\text{kg},$$

$$a = 27 b^2 P_c = 27 \times (0.000\,972\,98)^2 \times 7380 = 0.188\,6375 \text{ kPa (m}^3/\text{kg)}^2$$

The EOS is: 
$$P = \frac{RT}{v - b} - \frac{a}{v^2}$$

Since it is nonlinear in  $v$  we use trial and error starting with the Table entry.

$$v = 0.00345 : P = \frac{0.1889 \times 333.15}{0.00345 - 0.000\,972\,98} - \frac{0.188\,6375}{0.00345^2} = 9557.8 \text{ kPa low}$$

$$v = 0.003 : P = \frac{0.1889 \times 333.15}{0.003 - 0.000\,972\,98} - \frac{0.188\,6375}{0.003^2} = 10\,086.8 \text{ kPa high}$$

$$v = 0.00307 : P = \frac{0.1889 \times 333.15}{0.00307 - 0.000\,972\,98} - \frac{0.188\,6375}{0.00307^2} = 9995.4 \text{ OK.}$$

$$v = 0.00307 \text{ m}^3/\text{kg}$$

## 3.102

Solve the previous problem using the Redlich-Kwong equation of state. Notice this becomes trial and error.

Carbon dioxide from table A.2:  $T_c = 304.1 \text{ K}$ ,  $P_c = 7380 \text{ kPa}$ ,

$$T_r = T/T_c = 333.15/304.1 = 1.09553$$

For **Redlich-Kwong EOS** we have the parameters from Table D.1

$$b = 0.08664 \frac{RT_c}{P_c} = 0.08664 \times \frac{0.1889 \times 304.1}{7380} = 0.0006744 \text{ m}^3/\text{kg},$$

$$a = 0.42748 T_r^{-1/2} \frac{R^2 T_c^2}{P_c} = 0.42748 \times \frac{0.1889^2 \times 304.1^2}{1.09553^{1/2} \times 7380} = 0.18262 \text{ kPa (m}^3/\text{kg)}^2$$

The equation is:

$$P = \frac{RT}{v - b} - \frac{a}{v^2 + bv}$$

$$10\,000 = \frac{0.1889 \times 333.15}{v - 0.0006744} - \frac{0.18262}{v^2 + 0.0006744 \times v}$$

Trial and error on  $v$  (start guided by Table B.3.2):

$$v = 0.0035 \text{ m}^3/\text{kg} \quad \Rightarrow \quad P = 9772.8 \text{ kPa} \quad \text{so } v \text{ smaller}$$

$$v = 0.0033 \text{ m}^3/\text{kg} \quad \Rightarrow \quad P = 10044.7 \text{ kPa} \quad \text{so } v \text{ larger}$$

$$v = 0.0034 \text{ m}^3/\text{kg} \quad \Rightarrow \quad P = 9906.5 \text{ kPa}$$

linear interpolation gives

$$v = \mathbf{0.00333 \text{ m}^3/\text{kg}} \quad \Rightarrow \quad P = 10002.7 \text{ kPa} \quad \text{OK.}$$

**3.103**

Solve Problem 3.101 using the Soave equation of state,  $\omega = 0.239$ . Notice this becomes trial and error.

Carbon dioxide from table A.2:  $T_c = 304.1 \text{ K}$ ,  $P_c = 7380 \text{ kPa}$ ,

$$T_r = T/T_c = 333.15/304.1 = 1.09553$$

For **Soave EOS** see Appendix D (very close to Redlich-Kwong)

$$P = \frac{RT}{v - b} - \frac{a}{v^2 + bv}$$

where the parameters are from Table D.1 and D.4

$$\omega = 0.239$$

$$f = 0.48 + 1.574\omega - 0.176\omega^2 = 0.84613$$

$$a_0 = 0.42748 [1 + f(1 - T_r^{1/2})]^2 = 0.394381$$

$$b = 0.08664 \frac{RT_c}{P_c} = 0.08664 \times \frac{0.1889 \times 304.1}{7380} = 0.0006744 \text{ m}^3/\text{kg},$$

$$a = 0.394381 \frac{R^2 T_c^2}{P_c} = 0.394381 \times \frac{0.1889^2 \times 304.1^2}{7380} = 0.176342 \text{ kPa (m}^3/\text{kg)}^2$$

The equation is:

$$P = \frac{RT}{v - b} - \frac{a}{v^2 + bv}$$

$$10\,000 = \frac{0.1889 \times 333.15}{v - 0.0006744} - \frac{0.176342}{v^2 + 0.0006744 \times v}$$

Trial and error on  $v$  (start guided by Table B.3.2):

$$v = 0.0035 \text{ m}^3/\text{kg} \quad \Rightarrow \quad P = 10\,202 \text{ kPa} \quad \text{so } v \text{ larger}$$

$$v = 0.0036 \text{ m}^3/\text{kg} \quad \Rightarrow \quad P = 10\,051 \text{ kPa} \quad \text{so } v \text{ close}$$

$$v = \mathbf{0.00363 \text{ m}^3/\text{kg}} \quad \Rightarrow \quad P = 10\,006 \text{ kPa} \quad \text{OK}$$

## 3.104

A tank contains 8.35 kg methane in 0.1 m<sup>3</sup> at 250 K. Find the pressure using ideal gas, van der Waal EOS and the methane table.

The state is given by ( $T = 250$  K,  $v = V/m = 0.1/8.35 = 0.011976$  m<sup>3</sup>/kg)

Table A.2 or B.7.2:

$$T_c = 190.4 \text{ K,}$$

$$P_c = 4600 \text{ kPa}$$

$$T_r = \frac{T}{T_c} = \frac{250}{190.4} = 1.313$$

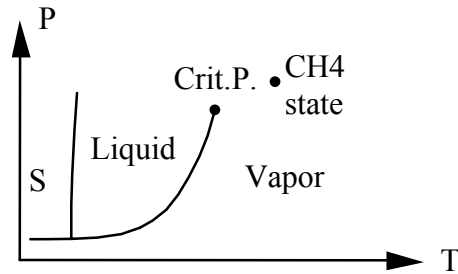

**Ideal gas model:** 
$$P = \frac{RT}{v} = \frac{0.5183 \times 250}{0.011976} = 10\,820 \text{ kPa}$$

For **van der Waal equation of state** from Table D.1 we have

$$b = \frac{1}{8} \frac{RT_c}{P_c} = 0.125 \times \frac{0.5183 \times 190.4}{4600} = 0.002\,681\,64 \text{ m}^3/\text{kg,}$$

$$a = 27 b^2 P_c = 27 \times (0.002\,681\,64)^2 \times 4600 = 0.893\,15 \text{ kPa (m}^3/\text{kg)}^2$$

The EOS is: 
$$P = \frac{RT}{v-b} - \frac{a}{v^2} = \frac{0.5183 \times 250}{0.011976 - 0.002\,681\,64} - \frac{0.89315}{0.011976^2} = 7714 \text{ kPa}$$

Locating the state in **Table B.7.2:**  $P = 8000$  kPa, very close

## 3.105

Do the previous problem using the Redlich-Kwong equation of state.

The state is given by ( $T = 250$  K,  $v = V/m = 0.1/8.35 = 0.011976$  m<sup>3</sup>/kg)

Table A.2 or B.7.2:

$$T_c = 190.4 \text{ K,}$$

$$P_c = 4600 \text{ kPa}$$

$$T_r = \frac{T}{T_c} = \frac{250}{190.4} = 1.313$$

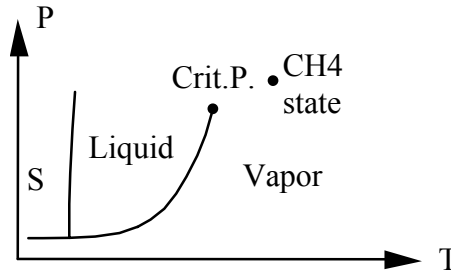

**Ideal gas model:** 
$$P = \frac{RT}{v} = \frac{0.5183 \times 250}{0.011976} = 10\,820 \text{ kPa}$$

For **Redlich-Kwong equation of state** we have the parameters from Table D.1

$$b = 0.08664 \frac{RT_c}{P_c} = 0.08664 \times \frac{0.5183 \times 190.4}{4600} = 0.001\,858\,7 \text{ m}^3/\text{kg},$$

$$a = 0.42748 T_r^{-1/2} \frac{R^2 T_c^2}{P_c} = 0.42748 \times \frac{0.5183^2 \times 190.4^2}{1.313^{1/2} \times 4600} = 0.789809 \text{ kPa (m}^3/\text{kg)}^2$$

The equation is:

$$\begin{aligned} P &= \frac{RT}{v - b} - \frac{a}{v^2 + bv} \\ &= \frac{0.5183 \times 250}{0.011976 - 0.0018587} - \frac{0.789809}{0.011976^2 + 0.0018587 \times 0.011976} \\ &= 8040 \text{ kPa} \end{aligned}$$

Locating the state in **Table B.7.2:**  $P = 8000$  kPa, very close



## 3.106

Do Problem 3.104 using the Soave EOS.

A tank contains 8.35 kg methane in 0.1 m<sup>3</sup> at 250 K. Find the pressure using ideal gas, van der Waal EOS and the methane table.

The state is given by ( $T = 250$  K,  $v = V/m = 0.1/8.35 = 0.011976$  m<sup>3</sup>/kg)

Table A.2 or B.7.2:

$$T_c = 190.4 \text{ K,}$$

$$P_c = 4600 \text{ kPa}$$

$$T_r = \frac{T}{T_c} = \frac{250}{190.4} = 1.313$$

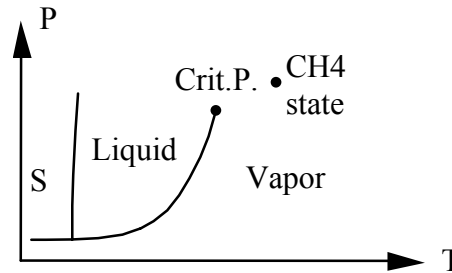

**Ideal gas model:** 
$$P = \frac{RT}{v} = \frac{0.5183 \times 250}{0.011976} = 10\,820 \text{ kPa}$$

For **Soave EOS** we have the parameters from Table D.1 and D.4

$$\omega = 0.011$$

$$f = 0.48 + 1.574\omega - 0.176\omega^2 = 0.49729$$

$$a_0 = 0.42748 [1 + f(1 - T_r^{1/2})]^2 = 0.367714$$

$$b = 0.08664 \frac{RT_c}{P_c} = 0.08664 \times \frac{0.5183 \times 190.4}{4600} = 0.001\,8587 \text{ m}^3/\text{kg,}$$

$$a = 0.367714 \frac{R^2 T_c^2}{P_c} = 0.367714 \times \frac{0.5183^2 \times 190.4^2}{4600} = 0.778\,482 \text{ kPa (m}^3/\text{kg)}^2$$

The equation is:

$$\begin{aligned} P &= \frac{RT}{v - b} - \frac{a}{v^2 + bv} \\ &= \frac{0.5183 \times 250}{0.011976 - 0.001\,8587} - \frac{0.778\,482}{0.011976^2 + 0.0018587 \times 0.011976} \\ &= \mathbf{8108.7 \text{ kPa}} \end{aligned}$$

Locating the state in **Table B.7.2:**  $P = 8000 \text{ kPa}$

## Review Problems

Excerpts from this work may be reproduced by instructors for distribution on a not-for-profit basis for testing or instructional purposes only to students enrolled in courses for which this textbook has been adopted. *Any other reproduction or translation of this work beyond that permitted by Sections 107 or 108 of the 1976 United States Copyright Act without the permission of the copyright owner is unlawful.*

## 3.107

Determine the quality (if saturated) or temperature (if superheated) of the following substances at the given two states:

Solution:

a) Water,  $H_2O$ , use Table B.1.1 or B.1.2

1)  $120^\circ\text{C}$ ,  $1 \text{ m}^3/\text{kg}$   $v > v_g$  superheated vapor,  $T = 120^\circ\text{C}$

2)  $10 \text{ MPa}$ ,  $0.01 \text{ m}^3/\text{kg}$   $\Rightarrow$  two-phase  $v < v_g$

$$x = (0.01 - 0.001452) / 0.01657 = \mathbf{0.516}$$

b) Nitrogen,  $N_2$ , table B.6

1)  $1 \text{ MPa}$ ,  $0.03 \text{ m}^3/\text{kg}$   $\Rightarrow$  superheated vapor since  $v > v_g$

Interpolate between sat. vapor and superheated vapor B.6.2:

$$T \cong 103.73 + (120 - 103.73) \times \frac{0.03 - 0.02416}{0.03117 - 0.02416} = \mathbf{117 \text{ K}}$$

2)  $100 \text{ K}$ ,  $0.03 \text{ m}^3/\text{kg}$   $\Rightarrow$  sat. liquid + vapor as two-phase  $v < v_g$

$$v = 0.03 = 0.001452 + x \times 0.029764 \Rightarrow \mathbf{x = 0.959}$$

States shown are placed relative to the two-phase region, not to each other.

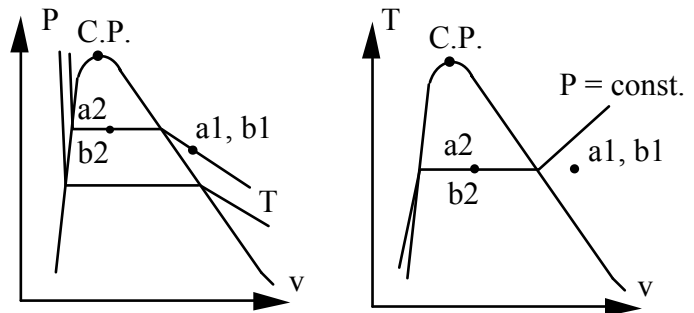

## 3.108

Give the phase and the missing properties of  $P$ ,  $T$ ,  $v$  and  $x$ .

Solution:

a. R-410a  $T = 10^\circ\text{C}$   $v = 0.01 \text{ m}^3/\text{kg}$

Table B.4.1  $v < v_g = 0.02383 \text{ m}^3/\text{kg}$

**sat. liquid + vapor.**  $P = P_{\text{sat}} = 1085.7 \text{ kPa}$ ,

$x = (v - v_f)/v_{fg} = (0.01 - 0.000886)/0.02295 = 0.2713$

b.  $\text{H}_2\text{O}$   $T = 350^\circ\text{C}$   $v = 0.2 \text{ m}^3/\text{kg}$

Table B.1.1 at given  $T$ :  $v > v_g = 0.00881 \text{ m}^3/\text{kg}$

**sup. vapor**  $P \cong 1.40 \text{ MPa}$ ,  $x = \text{undefined}$

c. R-410a  $T = -5^\circ\text{C}$   $P = 600 \text{ kPa}$

**sup. vapor** ( $P < P_g = 678.9 \text{ kPa}$  at  $-5^\circ\text{C}$ )

Table B.4.2:

$v = 0.04351 \text{ m}^3/\text{kg}$  at  $-8.67^\circ\text{C}$

$v = 0.04595 \text{ m}^3/\text{kg}$  at  $0^\circ\text{C}$

$\Rightarrow v = 0.04454 \text{ m}^3/\text{kg}$  at  $-5^\circ\text{C}$

d. R-134a  $P = 294 \text{ kPa}$ ,  $v = 0.05 \text{ m}^3/\text{kg}$

Table B.5.1:  $v < v_g = 0.06919 \text{ m}^3/\text{kg}$

**two-phase**  $T = T_{\text{sat}} = 0^\circ\text{C}$

$x = (v - v_f)/v_{fg} = (0.05 - 0.000773)/0.06842 = 0.7195$

States shown are placed relative to the two-phase region, not to each other.

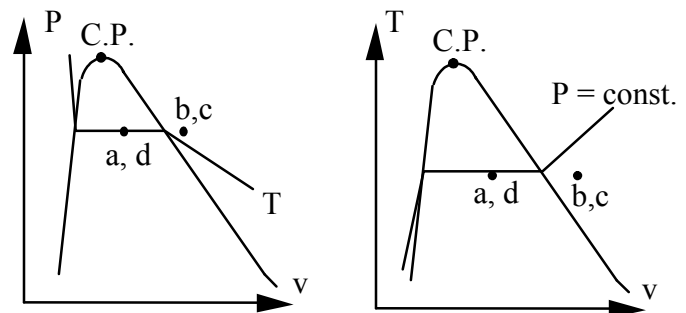

## 3.109

Find the phase, quality  $x$  if applicable and the missing property  $P$  or  $T$ .

Solution:

a.  $\text{H}_2\text{O}$   $T = 120^\circ\text{C}$   $v = 0.5 \text{ m}^3/\text{kg}$

Table B.1.1 at given  $T$ :  $v < v_g = 0.89186$

**sat. liq. + vap.**  $P = P_{\text{sat}} = \mathbf{198.5 \text{ kPa}}$ ,

$x = (v - v_f)/v_{fg} = (0.5 - 0.00106)/0.8908 = \mathbf{0.56}$

b.  $\text{H}_2\text{O}$   $P = 100 \text{ kPa}$   $v = 1.8 \text{ m}^3/\text{kg}$

Table B.1.2 at given  $P$ :  $v > v_g = 1.694$

**sup. vap.**, interpolate in Table B.1.3

$$T = \frac{1.8 - 1.694}{1.93636 - 1.694} (150 - 99.62) + 99.62 = \mathbf{121.65^\circ\text{C}}$$

c.  $\text{H}_2\text{O}$   $T = 263 \text{ K}$   $v = 0.2 \text{ m}^3/\text{kg}$

Table B.1.5 at given  $T = -10^\circ\text{C}$ :  $v < v_g = 466.757$

**sat. solid + vap.**,  $P = P_{\text{sat}} = \mathbf{0.26 \text{ kPa}}$ ,

$x = (v - v_i)/v_{ig} = (200 - 0.001)/466.756 = \mathbf{0.4285}$

States shown are placed relative to the two-phase region, not to each other.

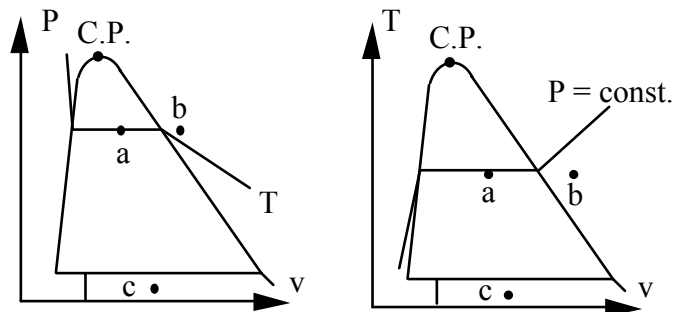

## 3.110

Find the phase, quality  $x$  if applicable and the missing property  $P$  or  $T$ .

Solution:

a.  $\text{NH}_3$   $P = 800 \text{ kPa}$   $v = 0.2 \text{ m}^3/\text{kg}$ ;

Superheated Vapor ( $v > v_g$  at 800 kPa)

Table B.2.2 interpolate between  $70^\circ\text{C}$  and  $80^\circ\text{C}$

$$T = 71.4^\circ\text{C}$$

b.  $\text{NH}_3$   $T = 20^\circ\text{C}$   $v = 0.1 \text{ m}^3/\text{kg}$

Table B.2.1 at given  $T$ :  $v < v_g = 0.14922$

**sat. liq. + vap.**,  $P = P_{\text{sat}} = 857.5 \text{ kPa}$ ,

$$x = (v - v_f)/v_{fg} = (0.1 - 0.00164)/0.14758 = 0.666$$

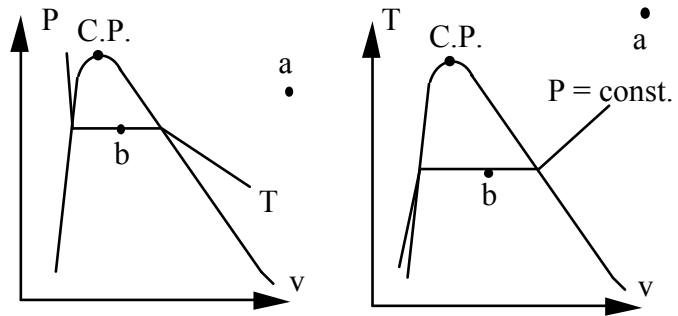

## 3.111

Give the phase and the missing properties of  $P$ ,  $T$ ,  $v$  and  $x$ . These may be a little more difficult if the appendix tables are used instead of the software.

- a) R-410a at  $T = 10^\circ\text{C}$ ,  $v = 0.02 \text{ m}^3/\text{kg}$ : Table B.4.1  $v > v_g$  at  $10^\circ\text{C}$   
 $\Rightarrow$  **sup. vap.** Table B.4.2 interpolate between sat. and sup. both at  $10^\circ\text{C}$

$$P = 680.7 + (600 - 680.7) \frac{0.036 - 0.03471}{0.04018 - 0.03471} = \mathbf{661.7 \text{ kPa}}$$

- b)  $\text{H}_2\text{O}$   $v = 0.2 \text{ m}^3/\text{kg}$ ,  $x = 0.5$ : Table B.1.1

$$\mathbf{\text{sat. liq. + vap.}} \quad v = (1-x)v_f + xv_g \Rightarrow v_f + v_g = 0.4 \text{ m}^3/\text{kg}$$

since  $v_f$  is so small we find it approximately where  $v_g = 0.4 \text{ m}^3/\text{kg}$ .

$$v_f + v_g = 0.39387 \text{ at } 150^\circ\text{C}, \quad v_f + v_g = 0.4474 \text{ at } 145^\circ\text{C}.$$

An interpolation gives  $T \cong \mathbf{149.4^\circ\text{C}}$ ,  $P \cong \mathbf{468.2 \text{ kPa}}$

- c)  $\text{H}_2\text{O}$   $T = 60^\circ\text{C}$ ,  $v = 0.001016 \text{ m}^3/\text{kg}$ : Table B.1.1  $v < v_f = 0.001017$

$\Rightarrow$  **compr. liq.** see Table B.1.4

$$v = 0.001015 \text{ at } 5 \text{ MPa so } P \cong 0.5(5000 + 19.9) = \mathbf{2.51 \text{ MPa}}$$

- d)  $\text{NH}_3$   $T = 30^\circ\text{C}$ ,  $P = 60 \text{ kPa}$ : Table B.2.1  $P < P_{\text{sat}}$

$\Rightarrow$  **sup. vapor** interpolate in Table B.2.2

$$v = 2.94578 + (1.95906 - 2.94578) \frac{60 - 50}{75 - 50} = \mathbf{2.551 \text{ m}^3/\text{kg}}$$

$v$  is not linearly proportional to  $P$  (more like  $1/P$ ) so the computer table gives a more accurate value of  $2.45 \text{ m}^3/\text{kg}$

- e) R-134a  $v = 0.005 \text{ m}^3/\text{kg}$ ,  $x = 0.5$ : **sat. liq. + vap.** Table B.5.1

$$v = (1-x)v_f + xv_g \Rightarrow v_f + v_g = 0.01 \text{ m}^3/\text{kg}$$

$$v_f + v_g = 0.010946 \text{ at } 65^\circ\text{C}, \quad v_f + v_g = 0.009665 \text{ at } 70^\circ\text{C}.$$

An interpolation gives:  $T \cong \mathbf{68.7^\circ\text{C}}$ ,  $P = \mathbf{2.06 \text{ MPa}}$

States shown are placed relative to the two-phase region, not to each other.

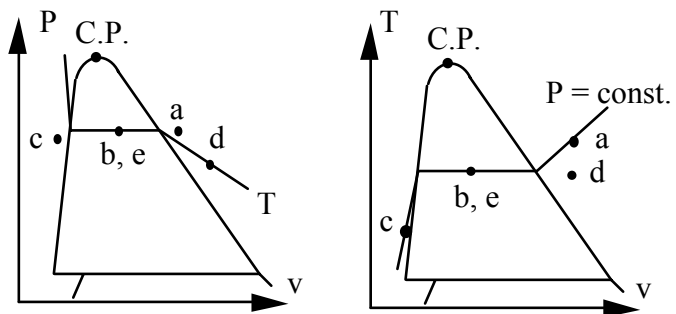

## 3.112

Refrigerant-410a in a piston/cylinder arrangement is initially at  $50^\circ\text{C}$ ,  $x = 1$ . It is then expanded in a process so that  $P = Cv^{-1}$  to a pressure of 100 kPa. Find the final temperature and specific volume.

Solution:

State 1:  $50^\circ\text{C}$ ,  $x = 1$  Table B.4.1:  $P_1 = 3065.2 \text{ kPa}$ ,  $v_1 = 0.00707 \text{ m}^3/\text{kg}$

Process:  $Pv = C = P_1v_1$ ;  $\Rightarrow P_2 = C/v_2 = P_1v_1/v_2$

State 2: 100 kPa and  $v_2 = v_1P_1/P_2 = \mathbf{0.2167 \text{ m}^3/\text{kg}}$

$v_2 < v_g$  at 100 kPa,  $T_2 \cong \mathbf{-51.65^\circ\text{C}}$  from Table B.3.2

Notice T is **not** constant

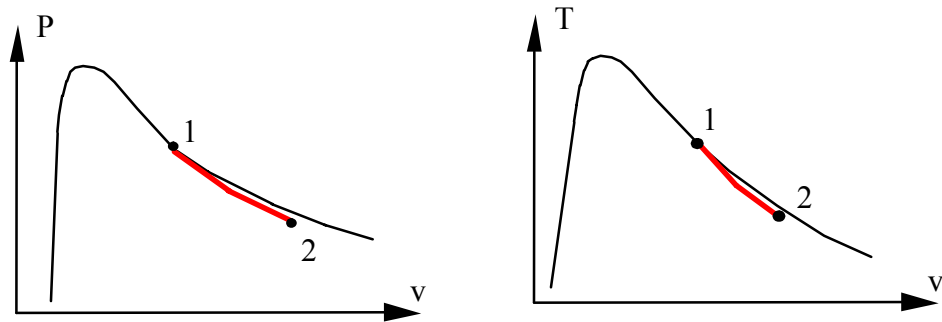

The first part of the process may be in the sup. vapor region.



## 3.113

Consider two tanks, A and B, connected by a valve, as shown in Fig. P3.113. Each has a volume of 200 L and tank A has R-410a at 25°C, 10% liquid and 90% vapor by volume, while tank B is evacuated. The valve is now opened and saturated vapor flows from A to B until the pressure in B has reached that in A, at which point the valve is closed. This process occurs slowly such that all temperatures stay at 25°C throughout the process. How much has the quality changed in tank A during the process?

Solution:

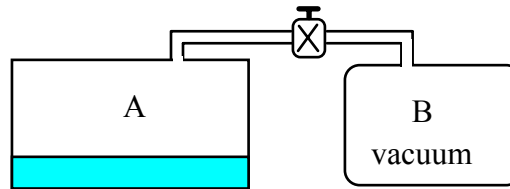

State A1: Table B.4.1  $v_f = 0.000944 \text{ m}^3/\text{kg}$ ,  $v_g = 0.01514 \text{ m}^3/\text{kg}$

$$m_{A1} = \frac{V_{\text{liq}1}}{v_{f, 25^\circ\text{C}}} + \frac{V_{\text{vap}1}}{v_{g, 25^\circ\text{C}}} = \frac{0.1 \times 0.2}{0.000944} + \frac{0.9 \times 0.2}{0.01514}$$

$$= 21.186 + 11.889 = 33.075 \text{ kg}$$

$$x_{A1} = \frac{11.889}{33.075} = 0.3594 ;$$

State B2: Assume A still two-phase so saturated P for given T

$$m_{B2} = \frac{V_B}{v_{g, 25^\circ\text{C}}} = \frac{0.2}{0.01514} = 13.210 \text{ kg}$$

State A2: mass left is  $m_{A2} = 33.075 - 13.210 = 19.865 \text{ kg}$

$$v_{A2} = \frac{0.2}{19.865} = 0.010068 = 0.000944 + x_{A2} \times 0.01420$$

$$x_{A2} = 0.6425 \quad \Delta x = \mathbf{0.283}$$

## 3.114

Water in a piston/cylinder is at 90°C, 100 kPa, and the piston loading is such that pressure is proportional to volume,  $P = CV$ . Heat is now added until the temperature reaches 200°C. Find the final pressure and also the quality if in the two-phase region.

Solution:

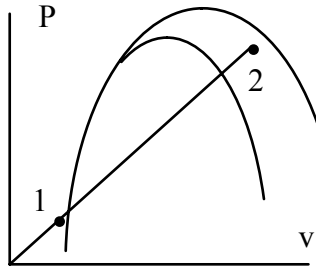

Final state: 200°C, on process line  $P = CV$

State 1: Table B.1.1:  $v_1 = 0.001036 \text{ m}^3/\text{kg}$

$$P_2 = P_1 v_2 / v_1 \quad \text{from process equation}$$

Check state 2 in Table B.1.1

$$v_g(T_2) = 0.12736; \quad P_g(T_2) = 1.5538 \text{ MPa}$$

$$\text{If } v_2 = v_g(T_2) \Rightarrow P_2 = 12.3 \text{ MPa} > P_g \quad \text{not OK}$$

$$\text{If sat. } P_2 = P_g(T_2) = 1553.8 \text{ kPa} \Rightarrow v_2 = 0.0161 \text{ m}^3/\text{kg} < v_g \quad \text{sat. OK,}$$

$$P_2 = 1553.8 \text{ kPa}, \quad x_2 = (0.0161 - 0.001156) / 0.1262 = \mathbf{0.118}$$

## 3.115

A tank contains 2 kg of nitrogen at 100 K with a quality of 50%. Through a volume flowmeter and valve, 0.5 kg is now removed while the temperature remains constant. Find the final state inside the tank and the volume of nitrogen removed if the valve/meter is located at

- The top of the tank
- The bottom of the tank

Solution

Table B.6.1:

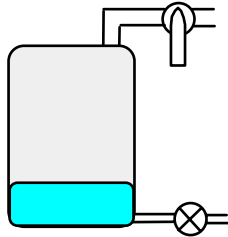

$$v_1 = 0.001452 + x_1 \times 0.029764 = 0.016334 \text{ m}^3/\text{kg}$$

$$V_{\text{tank}} = m_1 v_1 = 0.0327 \text{ m}^3$$

$$m_2 = m_1 - 0.5 = 1.5 \text{ kg}$$

$$v_2 = V_{\text{tank}}/m_2 = 0.0218 < v_g(T)$$

$$x_2 = \frac{0.0218 - 0.001452}{0.031216 - 0.001452} = \mathbf{0.6836}$$

Top: flow out is sat. vap.  $v_g = 0.031216 \text{ m}^3/\text{kg}$ ,  $V_{\text{out}} = m_{\text{out}} v_g = \mathbf{0.0156 \text{ m}^3}$

Bottom: flow out is sat. liq.  $v_f = 0.001452$   $V_{\text{out}} = m_{\text{out}} v_f = \mathbf{0.000726 \text{ m}^3}$

## 3.116

A spring-loaded piston/cylinder contains water at 500°C, 3 MPa. The setup is such that pressure is proportional to volume,  $P = CV$ . It is now cooled until the water becomes saturated vapor. Sketch the  $P$ - $v$  diagram and find the final pressure.

Solution:

$$\text{State 1: Table B.1.3: } v_1 = 0.11619 \text{ m}^3/\text{kg}$$

$$\text{Process: } m \text{ is constant and } P = C_0 V = C_0 m v = C v$$

$$P = Cv \Rightarrow C = P_1/v_1 = 3000/0.11619 = 25820 \text{ kPa kg/m}^3$$

$$\text{State 2: } x_2 = 1 \text{ \& } P_2 = Cv_2 \text{ (on process line)}$$

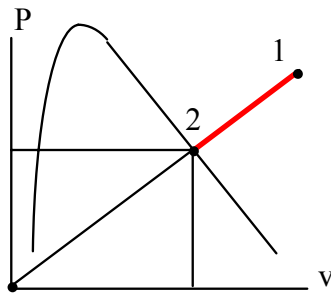

Trial & error on  $T_{2\text{sat}}$  or  $P_{2\text{sat}}$ :

Here from B.1.2:

$$\text{at 2 MPa } v_g = 0.09963 \Rightarrow C = 20074 \text{ (low)}$$

$$2.5 \text{ MPa } v_g = 0.07998 \Rightarrow C = 31258 \text{ (high)}$$

$$2.25 \text{ MPa } v_g = 0.08875 \Rightarrow C = 25352 \text{ (low)}$$

$$\text{Interpolate to get the right } C \Rightarrow P_2 = 2270 \text{ kPa}$$

## 3.117

A container with liquid nitrogen at 100 K has a cross sectional area of  $0.5 \text{ m}^2$ . Due to heat transfer, some of the liquid evaporates and in one hour the liquid level drops 30 mm. The vapor leaving the container passes through a valve and a heater and exits at 500 kPa, 260 K. Calculate the volume rate of flow of nitrogen gas exiting the heater.

Solution:

Properties from table B.6.1 for volume change, exit flow from table B.6.2:

$$\Delta V = A \times \Delta h = 0.5 \times 0.03 = 0.015 \text{ m}^3$$

$$\Delta m_{\text{liq}} = -\Delta V/v_f = -0.015/0.001452 = -10.3306 \text{ kg}$$

$$\Delta m_{\text{vap}} = \Delta V/v_g = 0.015/0.0312 = 0.4808 \text{ kg}$$

$$m_{\text{out}} = 10.3306 - 0.4808 = 9.85 \text{ kg}$$

$$v_{\text{exit}} = 0.15385 \text{ m}^3/\text{kg}$$

$$\begin{aligned} \dot{V} = \dot{m}v_{\text{exit}} &= (9.85 / 1 \text{ h}) \times 0.15385 \text{ m}^3/\text{kg} \\ &= 1.5015 \text{ m}^3/\text{h} = \mathbf{0.02526 \text{ m}^3/\text{min}} \end{aligned}$$

## 3.118

For a certain experiment, R-410a vapor is contained in a sealed glass tube at 20°C. It is desired to know the pressure at this condition, but there is no means of measuring it, since the tube is sealed. However, if the tube is cooled to -20°C small droplets of liquid are observed on the glass walls. What is the initial pressure?

Solution:

Control volume: R-410a fixed volume ( $V$ ) & mass ( $m$ ) at 20°C

Process: cool to -20°C at constant  $v$ , so we assume saturated vapor

State 2:  $v_2 = v_{g \text{ at } -20^\circ\text{C}} = 0.06480 \text{ m}^3/\text{kg}$

State 1: 20°C,  $v_1 = v_2 = 0.06480 \text{ m}^3/\text{kg}$

interpolate between 400 and 500 kPa in Table B.4.2

$$\Rightarrow \mathbf{P_1 = 485 \text{ kPa}}$$

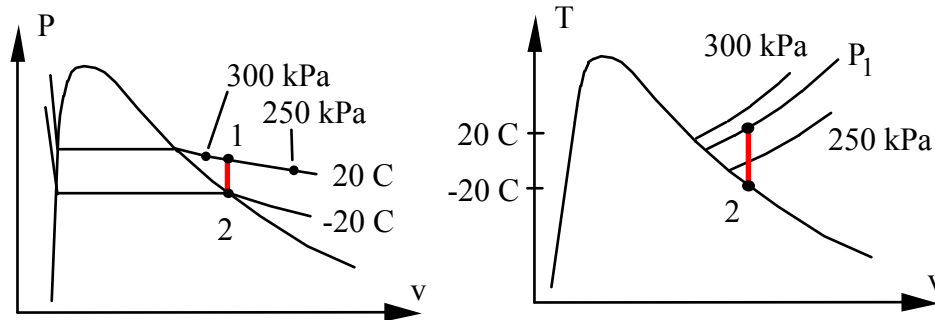

## 3.119

A cylinder/piston arrangement contains water at 105°C, 85% quality with a volume of 1 L. The system is heated, causing the piston to rise and encounter a linear spring as shown in Fig. P3.119. At this point the volume is 1.5 L, piston diameter is 150 mm, and the spring constant is 100 N/mm. The heating continues, so the piston compresses the spring. What is the cylinder temperature when the pressure reaches 200 kPa?

Solution:

$$P_1 = 120.8 \text{ kPa}, \quad v_1 = v_f + x v_{fg} = 0.001047 + 0.85 \cdot 1.41831 = 1.20661$$

$$m = V_1 / v_1 = \frac{0.001}{1.20661} = 8.288 \times 10^{-4} \text{ kg}$$

$$v_2 = v_1 (V_2 / V_1) = 1.20661 \times 1.5 = 1.8099$$

$$\& P = P_1 = 120.8 \text{ kPa} \quad (T_2 = 203.5^\circ\text{C})$$

$$P_3 = P_2 + (k_s / A_p^2) m (v_3 - v_2) \quad \text{linear spring}$$

$$A_p = (\pi/4) \times 0.15^2 = 0.01767 \text{ m}^2; \quad k_s = 100 \text{ kN/m (matches } P \text{ in kPa)}$$

$$200 = 120.8 + (100/0.01767^2) \times 8.288 \times 10^{-4} (v_3 - 1.8099)$$

$$200 = 120.8 + 265.446 (v_3 - 1.8099) \Rightarrow v_3 = 2.1083 \text{ m}^3/\text{kg}$$

$$T_3 \cong 600 + 100 \times (2.1083 - 2.01297)/(2.2443 - 2.01297) \cong 641^\circ\text{C}$$

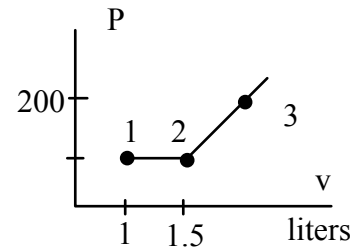

**3.120**

Determine the mass of methane gas stored in a 2 m<sup>3</sup> tank at -30°C, 2 MPa. Estimate the percent error in the mass determination if the ideal gas model is used.

Solution:

Table B.7

Methane Table B.7.1 at -30°C = 243.15 K > T<sub>c</sub> = 190.6 K, so superheated vapor in Table B.7.2. Linear interpolation between 225 and 250 K at 2 MPa.

$$\Rightarrow v \cong 0.05289 + \frac{243.15-225}{250-225} \times (0.06059 - 0.05289) = 0.05848 \text{ m}^3/\text{kg}$$

$$m = V/v = 2/0.05848 = \mathbf{34.2 \text{ kg}}$$

Ideal gas assumption

$$v = \frac{RT}{P} = \frac{0.51835 \times 243.15}{2000} = 0.06302 \text{ m}^3/\text{kg}$$

$$m = \frac{V}{v} = \frac{2}{0.06302} = 31.74 \text{ kg}$$

Error:

$$\Delta m = 2.46 \text{ kg}; \quad \mathbf{7.2\% \text{ too large}}$$

**Comment:** The compressibility of the methane  $Z = 0.93$ .



## 3.121

A cylinder containing ammonia is fitted with a piston restrained by an external force that is proportional to cylinder volume squared. Initial conditions are 10°C, 90% quality and a volume of 5 L. A valve on the cylinder is opened and additional ammonia flows into the cylinder until the mass inside has doubled. If at this point the pressure is 1.2 MPa, what is the final temperature?

Solution:

State 1 Table B.2.1:  $v_1 = 0.0016 + 0.9(0.205525 - 0.0016) = 0.18513 \text{ m}^3/\text{kg}$

$$P_1 = 615 \text{ kPa}; \quad V_1 = 5 \text{ L} = 0.005 \text{ m}^3$$

$$m_1 = V/v = 0.005/0.18513 = 0.027 \text{ kg}$$

State 2:  $P_2 = 1.2 \text{ MPa}$ , Flow in so:  $m_2 = 2 m_1 = 0.054 \text{ kg}$

Process: Piston  $F_{\text{ext}} = KV^2 = PA \Rightarrow P = CV^2 \Rightarrow P_2 = P_1 (V_2/V_1)^2$

From the process equation we then get:

$$V_2 = V_1 (P_2/P_1)^{1/2} = 0.005 \left(\frac{1200}{615}\right)^{1/2} = 0.006984 \text{ m}^3$$

$$v_2 = V/m = \frac{0.006984}{0.054} = 0.12934 \text{ m}^3/\text{kg}$$

$$\text{At } P_2, v_2: \quad T_2 = \mathbf{70.9^\circ\text{C}}$$

## 3.122

A cylinder has a thick piston initially held by a pin as shown in Fig. P3.122. The cylinder contains carbon dioxide at 200 kPa and ambient temperature of 290 K. The metal piston has a density of 8000 kg/m<sup>3</sup> and the atmospheric pressure is 101 kPa. The pin is now removed, allowing the piston to move and after a while the gas returns to ambient temperature. Is the piston against the stops?

Solution:

Force balance on piston determines equilibrium float pressure.

$$\text{Piston } m_p = A_p \times l \times \rho \qquad \rho_{\text{piston}} = 8000 \text{ kg/m}^3$$

$$P_{\text{ext on CO}_2} = P_0 + \frac{m_p g}{A_p} = 101 + \frac{A_p \times 0.1 \times 9.807 \times 8000}{A_p \times 1000} = 108.8 \text{ kPa}$$

Pin released, as  $P_1 > P_{\text{ext}}$  piston moves up,  $T_2 = T_0$  & if piston at stops,

$$\text{then } V_2 = V_1 \times H_2/H_1 = V_1 \times 150 / 100$$

Ideal gas with  $T_2 = T_1$  then gives

$$\Rightarrow P_2 = P_1 \times V_1 / V_2 = 200 \times \frac{100}{150} = 133 \text{ kPa} > P_{\text{ext}}$$

$$\Rightarrow \text{piston is at stops, and } P_2 = 133 \text{ kPa}$$

## 3.123

What is the percent error in pressure if the ideal gas model is used to represent the behavior of superheated vapor R-410a at 60°C, 0.03470 m<sup>3</sup>/kg? What if the generalized compressibility chart, Fig. D.1, is used instead (iterations needed)?

Solution:

Real gas behavior:  $P = 1000 \text{ kPa}$  from Table B.4.2

Ideal gas constant:  $R = \bar{R}/M = 8.31451/72.585 = 0.1146 \text{ kJ/kg K}$

$$P = RT/v = 0.1146 \times (273.15 + 60) / 0.0347$$

$$= \mathbf{1100 \text{ kPa which is 10\% too high}}$$

Generalized chart Fig D.1 and critical properties from A.2:

$$T_r = 333.2/(273.15 + 71.3) = 0.967; \quad P_c = 4901 \text{ kPa}$$

Assume  $P = 1000 \text{ kPa} \Rightarrow P_r = 0.204 \Rightarrow Z \cong 0.92$

$$v = ZRT/P = 0.92 \times 0.1146 \times 333.15 / 1000 = 0.03512 \text{ too high}$$

Assume  $P = 1050 \text{ kPa} \Rightarrow P_r = 0.214 \Rightarrow Z \cong 0.915$

$$v = ZRT/P = 0.915 \times 0.1146 \times 333.15 / 1050 = 0.03327 \text{ too low}$$

$$P \cong 1000 + (1050 - 1000) \times \frac{0.03470 - 0.03512}{0.03327 - 0.03512} = \mathbf{1011 \text{ kPa 1.1 \% high}}$$

## 3.124

An initially deflated and flat balloon is connected by a valve to a 12 m<sup>3</sup> storage tank containing helium gas at 2 MPa and ambient temperature, 20°C. The valve is opened and the balloon is inflated at constant pressure,  $P_0 = 100$  kPa, equal to ambient pressure, until it becomes spherical at  $D_1 = 1$  m. If the balloon is larger than this, the balloon material is stretched giving a pressure inside as

$$P = P_0 + C \left(1 - \frac{D_1}{D}\right) \frac{D_1}{D}$$

The balloon is inflated to a final diameter of 4 m, at which point the pressure inside is 400 kPa. The temperature remains constant at 20°C. What is the maximum pressure inside the balloon at any time during this inflation process? What is the pressure inside the helium storage tank at this time?

Solution:

At the end of the process we have  $D = 4$  m so we can get the constant  $C$  as

$$P = 400 = P_0 + C \left(1 - \frac{1}{4}\right) \frac{1}{4} = 100 + C \times 3/16 \quad \Rightarrow \quad C = 1600 \text{ kPa}$$

$$\text{The pressure is: } P = 100 + 1600 (1 - X^{-1}) X^{-1}; \quad X = D / D_1$$

$$\text{Differentiate to find max: } \frac{dP}{dD} = C (-X^{-2} + 2X^{-3}) / D_1 = 0$$

$$\Rightarrow -X^{-2} + 2X^{-3} = 0 \Rightarrow X = 2$$

$$\text{at max } P \Rightarrow D = 2D_1 = 2 \text{ m}; \quad V = \frac{\pi}{6} D^3 = 4.18 \text{ m}^3$$

$$P_{\max} = 100 + 1600 \left(1 - \frac{1}{2}\right) \frac{1}{2} = \mathbf{500 \text{ kPa}}$$

$$\text{Helium is ideal gas A.5: } m = \frac{PV}{RT} = \frac{500 \times 4.189}{2.0771 \times 293.15} = 3.44 \text{ kg}$$

$$m_{\text{TANK},1} = \frac{PV}{RT} = \frac{2000 \times 12}{2.0771 \times 293.15} = 39.416 \text{ kg}$$

$$m_{\text{TANK},2} = 39.416 - 3.44 = 35.976 \text{ kg}$$

$$P_{T2} = m_{\text{TANK},2} RT/V = (m_{\text{TANK},1} / m_{\text{TANK},2}) \times P_1 = \mathbf{1825.5 \text{ kPa}}$$

## 3.125

A piston/cylinder arrangement, shown in Fig. P3.125, contains air at 250 kPa, 300°C. The 50-kg piston has a diameter of 0.1 m and initially pushes against the stops. The atmosphere is at 100 kPa and 20°C. The cylinder now cools as heat is transferred to the ambient.

- At what temperature does the piston begin to move down?
- How far has the piston dropped when the temperature reaches ambient?

Solution:

$$\text{Piston } A_p = \frac{\pi}{4} \times 0.1^2 = 0.00785 \text{ m}^2$$

Balance forces when piston floats:

$$P_{\text{float}} = P_o + \frac{m_p g}{A_p} = 100 + \frac{50 \times 9.807}{0.00785 \times 1000}$$

$$= 162.5 \text{ kPa} = P_2 = P_3$$

To find temperature at 2 assume ideal gas:

$$T_2 = T_1 \times \frac{P_2}{P_1} = 573.15 \times \frac{162.5}{250} = \mathbf{372.5 \text{ K}}$$

- b) Process 2 → 3 is constant pressure as piston floats to  $T_3 = T_o = 293.15 \text{ K}$

$$V_2 = V_1 = A_p \times H = 0.00785 \times 0.25 = 0.00196 \text{ m}^3 = 1.96 \text{ L}$$

$$\text{Ideal gas and } P_2 = P_3 \Rightarrow V_3 = V_2 \times \frac{T_3}{T_2} = 1.96 \times \frac{293.15}{372.5} = \mathbf{1.54 \text{ L}}$$

$$\Delta H = (V_2 - V_3)/A = (1.96 - 1.54) \times 0.001/0.00785 = \mathbf{0.053 \text{ m} = 5.3 \text{ cm}}$$

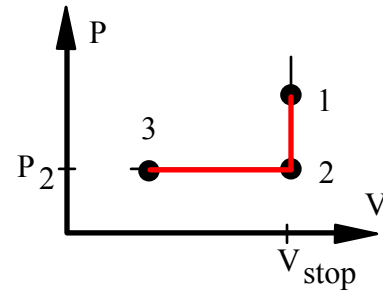

## Linear Interpolation

Excerpts from this work may be reproduced by instructors for distribution on a not-for-profit basis for testing or instructional purposes only to students enrolled in courses for which this textbook has been adopted. *Any other reproduction or translation of this work beyond that permitted by Sections 107 or 108 of the 1976 United States Copyright Act without the permission of the copyright owner is unlawful.*

## 3.126

Find the pressure and temperature for saturated vapor R-410a with  $v = 0.1 \text{ m}^3/\text{kg}$

Solution:

Table B.4.1 Look at the saturated vapor column  $v_g$  and it is found between  $-35^\circ\text{C}$  and  $-30^\circ\text{C}$ . We must then do a linear interpolation between these values.

$$T = -35 + [-30 - (-35)] \frac{0.1 - 0.11582}{0.09470 - 0.11582}$$

$$= -35 + 5 \times 0.749 = -31.3^\circ\text{C}$$

$$P = 218.4 + (269.6 - 218.4) \times 0.749 = 256.7 \text{ kPa}$$

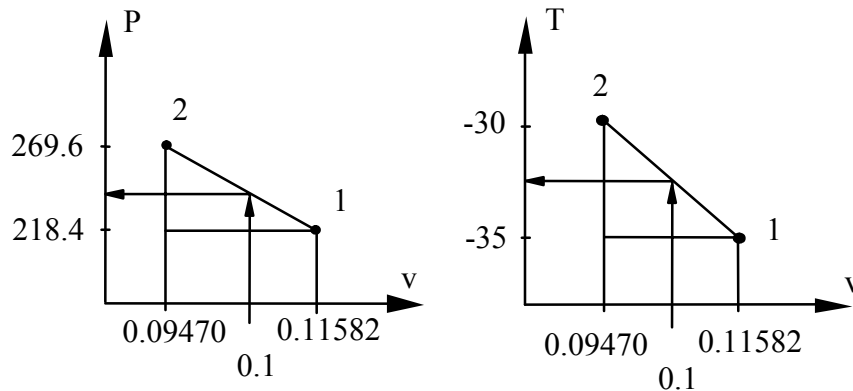

To understand the interpolation equation look at the smaller and larger triangles formed in the figure. The ratio of the side of the small triangle in  $v$  as  $(0.11582 - 0.1)$  to the side of the large triangle  $(0.11582 - 0.09470)$  is equal to 0.749. This fraction of the total  $\Delta P = 269.6 - 218.4$  or  $\Delta T = -30 - (-35)$  is added to the lower value to get the desired interpolated result.

## 3.127

Use a linear interpolation to estimate properties of ammonia to fill out the table below

	P [kPa]	T [°C]	v [m <sup>3</sup> /kg]	x
a)	550			0.75
b)	80	20		
c)		10	0.4	

Solution:

- a) Find the pressures in Table B.2.1 that brackets the given pressure.

$$T = 5 + (10 - 5) \frac{550 - 515.9}{615.2 - 515.9} = 5 + 5 \times 0.341 = \mathbf{6.7\text{ }^\circ\text{C}}$$

$$v_f = 0.001583 + (0.0016 - 0.001583) 0.341 = 0.001589 \text{ m}^3/\text{kg}$$

$$v_g = 0.24299 + (0.20541 - 0.24299) 0.341 = 0.230175 \text{ m}^3/\text{kg}$$

$$v = v_f + xv_{fg} = 0.001589 + 0.75(0.230175 - 0.001589)$$

$$= \mathbf{0.1729 \text{ m}^3/\text{kg}}$$

- b) Interpolate between 50 and 100 kPa to get properties at 80 kPa

$$v = 2.8466 + (1.4153 - 2.8466) \frac{80 - 50}{100 - 50}$$

$$= 2.8466 + (-1.4313) \times 0.6 = \mathbf{1.9878 \text{ m}^3/\text{kg}}$$

x: Undefined

- c) Table B.2.1:  $v > v_g$  so the state is superheated vapor.

Table B.2.2 locate state between 300 and 400 kPa.

$$P = 300 + (400 - 300) \frac{0.4 - 0.44251}{0.32701 - 0.44251}$$

$$= 300 + 100 \times 0.368 = \mathbf{336.8 \text{ kPa}}$$

x: Undefined



## 3.128

Use a linear interpolation to estimate  $T_{\text{sat}}$  at 900 kPa for nitrogen. Sketch by hand the curve  $P_{\text{sat}}(T)$  by using a few table entries around 900 kPa from table B.6.1. Is your linear interpolation over or below the actual curve?

Solution:

The 900 kPa in Table B.6.1 is located between 100 and 105 K.

$$\begin{aligned} T &= 100 + (105 - 100) \frac{900 - 779.2}{1084.6 - 779.2} \\ &= 100 + 5 \times 0.3955 = \mathbf{102 \text{ K}} \end{aligned}$$

The actual curve has a positive second derivative (it curves up) so  $T$  is slightly underestimated by use of the chord between the 100 K and the 105 K points, as the chord is above the curve.

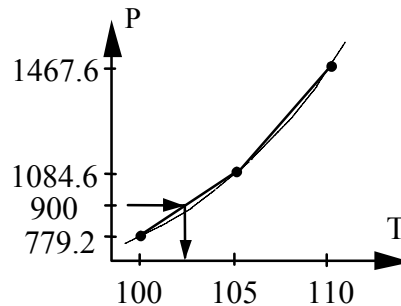

**3.129**

Use a double linear interpolation to find the pressure for superheated R-134a at 13°C with  $v = 0.3 \text{ m}^3/\text{kg}$ .

Solution:

Table B.5.2: Superheated vapor

At 10°C, 0.3 m<sup>3</sup>/kg

$$P = 50 + (100 - 50) \times \frac{0.3 - 0.45608}{0.22527 - 0.45608} = 83.8 \text{ kPa}$$

At 20°C, 0.3 m<sup>3</sup>/kg

$$P = 50 + (100 - 50) \times \frac{0.3 - 0.47287}{0.23392 - 0.47287} = 86.2 \text{ kPa}$$

Interpolating at 13°C,

$$P = 83.8 + (3/10) \times (86.2 - 83.8) = \mathbf{84.5 \text{ kPa}}$$

This could also be interpolated as following:

$$\text{At } 13^\circ\text{C, } 50 \text{ kPa, } \quad v = 0.45608 + (3/10) \times 0.0168 = 0.4611 \text{ m}^3/\text{kg}$$

$$\text{At } 13^\circ\text{C, } 100 \text{ kPa, } \quad v = 0.22527 + (3/10) \times 0.0087 = 0.2279 \text{ m}^3/\text{kg}$$

Interpolating at 0.3 m<sup>3</sup>/kg.

$$P = 50 + (100 - 50) \times \frac{0.3 - 0.4611}{0.2279 - 0.4611} = \mathbf{84.5 \text{ kPa}}$$

**3.130**

Find the specific volume for CO<sub>2</sub> at 0°C and 625 kPa.

Solution:

The state is superheated vapor in Table B.3.2 between 400 and 800 kPa.

$$\begin{aligned}v &= 0.12552 + (0.06094 - 0.12552) \frac{625 - 400}{800 - 400} \\ &= 0.12552 + (-0.06458) \times 0.5625 = \mathbf{0.0892 \text{ m}^3/\text{kg}}\end{aligned}$$

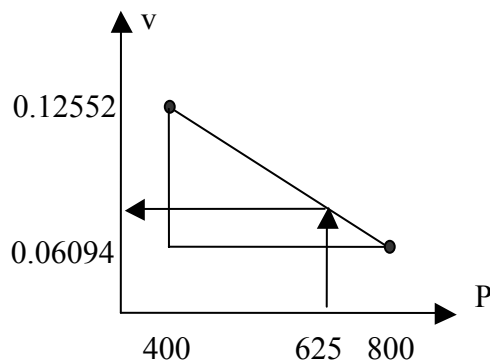

## Computer Tables

Excerpts from this work may be reproduced by instructors for distribution on a not-for-profit basis for testing or instructional purposes only to students enrolled in courses for which this textbook has been adopted. *Any other reproduction or translation of this work beyond that permitted by Sections 107 or 108 of the 1976 United States Copyright Act without the permission of the copyright owner is unlawful.*

**3.131**

Use the computer software to find the properties for water at the 4 states in Problem 3.35

Start the software, click the tab for water as the substance, and click the small calculator icon. Select the proper CASE for the given properties.

CASE	RESULT
a) 1 (T, P)	Compressed liquid, $x = \text{undefined}$ , $v = 0.001002 \text{ m}^3/\text{kg}$
b) 5 (P, $v$ )	Two-phase, $T = 151.9^\circ\text{C}$ , $x = 0.5321$
c) 1 (T, P)	Sup. vapor, $x = \text{undefined}$ , $v = 0.143 \text{ m}^3/\text{kg}$
d) 4 (T, $x$ )	$P = P_{\text{sat}} = 8581 \text{ kPa}$ , $v = 0.01762 \text{ m}^3/\text{kg}$

**3.132**

Use the computer software to find the properties for ammonia at the 2 states listed in Problem 3.32

Start the software, click the tab for cryogenic substances, and click the tab for the substance ammonia. Then click the small calculator icon and select the proper CASE for the given properties.

	CASE	RESULT
a)	2 (T, v)	Sup. vapor, $x = \text{undefined}$ , $P = 1200 \text{ kPa}$
b)	4 (T, x)	Two-phase, $P = 2033 \text{ kPa}$ , $v = 0.03257 \text{ m}^3/\text{kg}$

**3.133**

Use the computer software to find the properties for ammonia at the 3 states listed in Problem 3.127

Start the software, click the tab for cryogenic substances, select ammonia and click the small calculator icon. Select the proper CASE for the given properties.

	CASE	RESULT
a)	8 (P, x)	$T = 6.795^{\circ}\text{C}$ , $v = 0.1719 \text{ m}^3/\text{kg}$
b)	1 (T, P)	Sup. vapor, $x = \text{undefined}$ , $v = 1.773 \text{ m}^3/\text{kg}$
c)	2 (T, v)	Sup. vapor, $x = \text{undefined}$ , $P = 330.4 \text{ kPa}$

## 3.134

Find the value of the saturated temperature for nitrogen by linear interpolation in table B.6.1 for a pressure of 900 kPa. Compare this to the value given by the computer software.

The 900 kPa in Table B.6.1 is located between 100 and 105 K.

$$\begin{aligned} T &= 100 + (105 - 100) \frac{900 - 779.2}{1084.6 - 779.2} \\ &= 100 + 5 \times 0.3955 = 101.98 \text{ K} \end{aligned}$$

The actual curve has a positive second derivative (it curves up) so T is slightly underestimated by use of the chord between the 100 K and the 105 K points, as the chord is above the curve.

From the computer software:

$$\text{CASE: } 8 \text{ (P,x)} \quad T = -171^\circ\text{C} = 102.15 \text{ K}$$

So we notice that the curvature has only a minor effect.

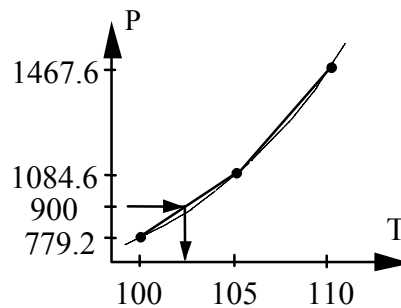



**3.135**

Use the computer software to sketch the variation of pressure with temperature in Problem 3.44. Extend the curve a little into the single-phase region.

P was found for a number of temperatures. A small table of (P, T) values were entered into a spreadsheet and a graph made as shown below. The superheated vapor region is reached at about  $140^{\circ}\text{C}$  and the graph shows a small kink at that point.

